

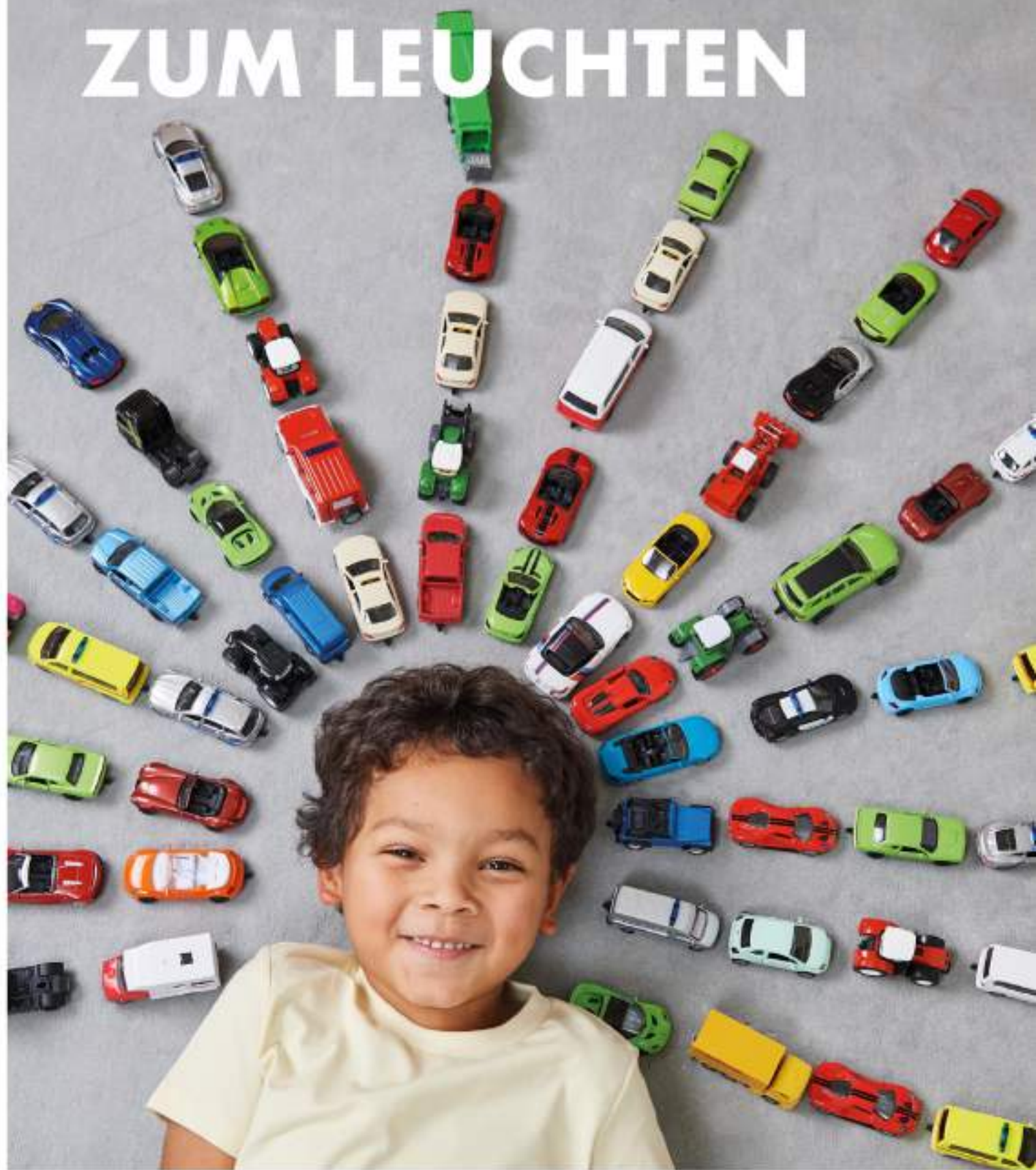

2024



SIKU BRINGT KINDERAUGEN ZUM LEUCHTEN



**SIKU LIGHTS UP
CHILDREN'S EYES**

**SIKU FAIT
BRILLER LES YEUX DES
ENFANTS**



Seite
Page 6-7



Seite
Page 9-14

NEUHEITEN
NEWS • NOUVEAUTÉS

Seite
Page 15-31

SIKUSUPER BLISTER

Seite
Page 32-53

SIKUSUPER

Seite
Page 54-60

SIKUWORLD

Seite
Page 61-70

SIKUCONTROL

Seite
Page 71-83

SIKUFARMER

Seite
Page 84-96

SIKUIINTERNATIONAL

Seite
Page 97-99

ALLGEMEIN
MISCELLANEOUS • GÉNÉRALITÉS

Seite
Page 100-103





Produktion, Verwaltung und Museum in Deutschland
Production, administration and museum in Germany
Fabrication, administration et musée en Allemagne

Die Sieper-Group

Das vor 100 Jahren gegründete Familienunternehmen aus dem Sauerland in Deutschland ist mit den Marken siku, Toddys by siku und WIKING eines der führenden Spielwarenunternehmen in Europa.

Wir stellen in unseren Fertigungsstätten in Deutschland, Polen und China nicht nur hochwertiges Spielzeug her, das den neuesten europäischen und internationalen Normen und Qualitätsstandards entspricht, sondern wir produzieren auch Freude und Spielspaß bei unseren großen und kleinen Fans in über 60 Ländern der Welt. Diese Begeisterung ist der Motor, der uns antreibt.

The group Sieper

With its brands siku, Toddys by siku and WIKING, our German family business which was founded 100 years ago is one of Europe's leading toy companies.

At our production facilities in Germany, Poland and China, we not only manufacture high-quality toys that meet the latest European and international regulatory and quality standards, but also create joy and the fun of play for our fans both young and old in more than 60 countries around the world. Their enthusiasm is our motivation.

L'entreprise

Notre entreprise familiale fondée il y a 100 ans de cela se classe aujourd'hui parmi les fabricants de jouets leaders en Europe grâce à ses marques siku, Toddys by siku et WIKING.

Au sein de nos sites de production situés en Allemagne, Pologne et Chine, nous fabriquons des jouets d'excellente qualité répondant aux toutes dernières normes et aux standards de qualité européens et internationaux, mais aussi de la joie et du plaisir de jouer pour nos fans, petits et grands, répartis dans plus de 60 pays dans le monde entier. Leur enthousiasme constitue notre motivation première.



Polen



China

Internationale Produktionsstätten
Production plants abroad
Lieux de production à l'étranger



Entwicklung und Forschung auf höchstem Niveau
Research and development at the highest level
Recherche et développement au plus haut niveau

ZERTIFIZIERUNGEN* CERTIFICATIONS*



*Produktzertifizierungen nur für ausgewählte Produkte · Product certifications only for selected products · Certification délivrée exclusivement pour des produits sélectionnés

Alle Zubehörteile, die im Produktbild abgebildet sind, sind auch im Lieferumfang enthalten. Technische und farbliche Änderungen an den Modellen behalten wir uns vor. All the illustrated accessory parts shown in the product images are also included in the scope of delivery. We reserve the right to make technical or colour amendments.

Tous les accessoires représentés dans les photos de produits sont également fournis. Nous nous réservons le droit de modifications techniques ou de couleurs.

Die aktuellen siku-AGB's finden Sie auf unserer Internetseite unter: The current general terms and conditions of siku can be downloaded on: Vous trouvez les C.G.V. siku sur notre site Internet:

SIKUWEBSITE + SHOP

Spielspaß spricht viele Sprachen.
Unsere Websites sprechen:
Deutsch, Französisch, Englisch,
Holländisch und Polnisch

Fun is multilingual.

Our websites speak:
German, French, English,
Dutch and Polish

Le plaisir de jouer s'exprime
dans de nombreuses langues.
Nos sites parlent:
allemand, français, anglais,
hollandais et polonais

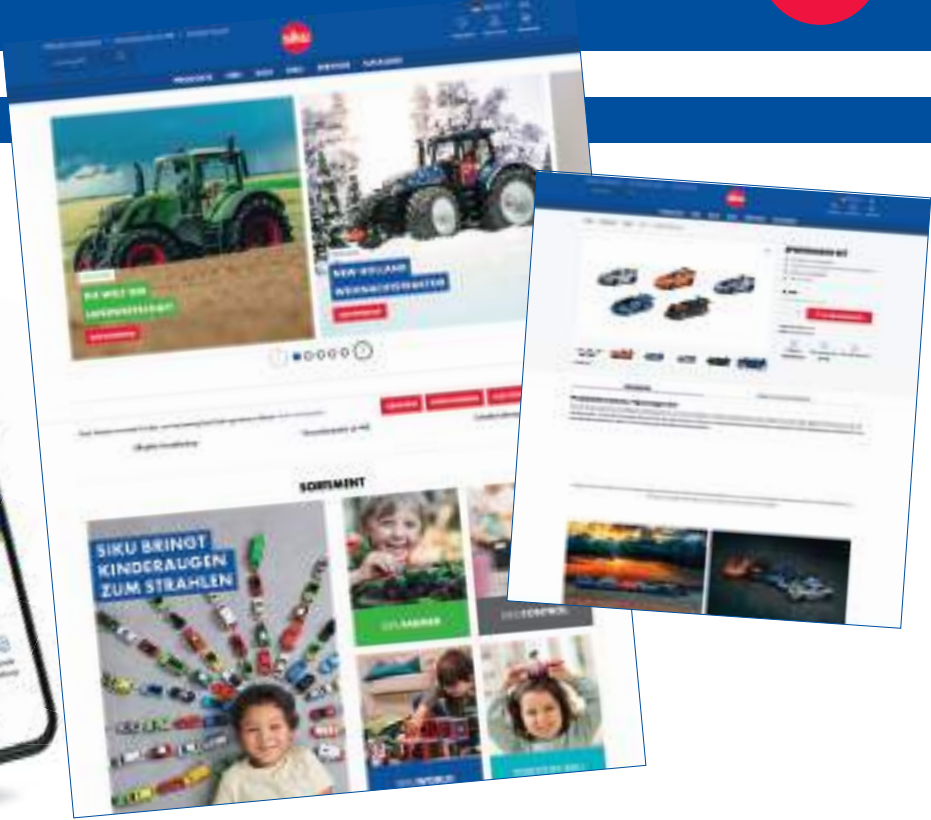
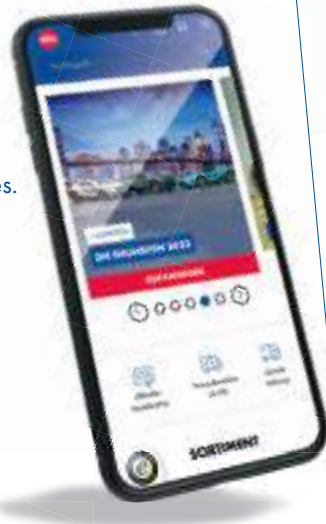

SIKUMEDIACENTER

<https://sat.siku.c3n.cloud/login/registration>

Neue Funktionen und leichte Navigation: Das neue siku MediaCenter ist jetzt verfügbar. Hier finden Sie aktuelle Informationen und Medieninhalte (Assets) rund um unsere Marken siku, WIKING und Toddy's by siku für Ihre Marketingaktivitäten. Einfach registrieren und los geht's.



New functions and easy navigation: The new siku MediaCenter is now available. You will find current information and media content (assets) related to our brands siku, WIKING and Toddy's by siku, for your marketing activities. Simply register and off you go.

Nouvelles fonctions et navigation aisée : Le nouveau MediaCenter siku est à présent disponible. Vous y trouverez des informations et des contenus médias actualisés (Assets) concernant les marques siku, WIKING et Toddy's by siku pour vos activités marketing. Il suffit de s'inscrire et c'est parti.



SIKUSOCIAL MEDIA



Immer top informiert. Nutzen Sie unsere Social Media und Online-Kanäle und erleben die Welt von siku.



Where to find the latest siku news. Use our social-media and online channels to experience the world of siku.

Toujours parfaitement informé. Utilisez les médias sociaux et nos canaux en ligne pour découvrir l'univers de siku.

Katalog · catalogue

Unser neuer PDF Blätterkatalog auf der Website.

Our new digital product catalogue on our website.

Notre nouveau catalogue numérique interactif sur notre site web.

Mit einer intuitiven Navigation und vielen tollen neuen und zusätzlichen Funktionen ausgestattet.

Featuring intuitive navigation and lots of great additional and new functions.

Il vous offre une navigation intuitive et de nombreuses et très pratiques fonctions supplémentaires.



WAS UNS BEWEGT...

WHAT DRIVES US ...
CE QUI NOUS MOTIVE SINON ...

Spielspaß • Fun playing • Le plaisir de jouer

Nichts ist schöner, als glückliche, strahlende Kinder, die in ihrer eigenen Welt versunken sind. Für diese Momente steht siku. Ob für kleine Kinder oder Menschen, die sich ein Stück kindliche Begeisterung bewahrt haben.

Nothing could be more wonderful than the sight of happy children immersed in their own little world, their eyes sparkling with joy. These moments are what siku is all about – no matter whether it's little children or adults who have retained a little of their childhood fascination with our toys.

Rien n'est plus beau que d'observer des enfants heureux aux yeux rayonnants plongés dans leur propre univers. Ces moments constituent la motivation première de siku. Pour les jeunes enfants tout comme pour les adultes qui ont su préserver leur âme d'enfant.

Spielspaß
Fun playing
Le plaisir de jouer





Stabilität
Stability
La robustesse

Qualität
Quality
La qualité

Sicherheit
Safety
La sécurité

Kompatibilität
Compatibility
Compatibilité

Nachhaltigkeit
Sustainability
Durabilité

Detailtreue
True to detail
Le souci du détail

Langlebigkeit
Longevity
Durée de vie

Sicherheit
Safety
La sécurité

Unser Spielzeug bietet ein Höchstmaß an Sicherheit, weil wir wollen, dass Kinder unbeschwert spielen können und Eltern sich keine Sorgen machen müssen.

Our toys offer the highest benchmarks in terms of safety, because we want children to enjoy worry-free play and to offer parents peace of mind.

Nos jouets offrent un niveau maximal de sécurité car nous souhaitons que les enfants puissent jouer en toute insouciance et que leurs parents soient parfaitement rassurés.

Stabilität
Stability
La robustesse

In der Entwicklung von innovativen neuen Produkten werden diese auf Herz und Nieren getestet und unterschiedlichen Materialprüfungen unterzogen. Wir überlassen hier nichts dem Zufall.

When developing innovative new products, we thoroughly test them and subject them to various material analyses and stress tests. We leave nothing to chance.

Lors du développement de nouveaux produits innovants, nous effectuons des tests approfondis, notamment des différents matériaux et de leur résistance. Nous ne laissons rien au hasard.

Detailtreue
True to detail
Le souci du détail

Wir arbeiten immer mit Liebe zum Detail. Ein Grund warum Lizenz-Partner von Automobilherstellern uns vertrauen. Bei unserer Spielzeugentwicklung achten wir auf Materialien, Farben und Bedruckungen und eine optimale Haptik für Kinderhände.

We work with a keen eye for detail. It's one of the reasons so many licensing partners put their faith in us. When developing our toys, we pay attention to the choice of materials, colours and prints, as well as the perfect tactile experience for children.

Nous prêtons attention au moindre détail. C'est l'une des raisons qui nous valent la confiance de tant de partenaires sous licence. Lors du développement de nos jouets, nous prêtons une grande attention au matériaux, couleurs et impressions ainsi qu'à une haptique optimale adaptée aux mains des enfants.

Langlebigkeit
Longevity
Durée de vie

Unser Spielzeug ist so robust, dass diese zum Teil an die nächste Generation vererbt werden. Für uns nicht nur eine schöne Form Generationen zu verbinden, sondern auch ein Beitrag von Nachhaltigkeit.

Our toys are so robust that they are handed down to the next generation. We see this not just as a wonderful way to connect the generations, but also as an opportunity to contribute to a more sustainable world.

Nos jouets sont si robustes qu'ils peuvent être transmis de génération en génération. Ceci constitue pour nous une belle manière de créer du lien entre les générations, mais aussi de promouvoir la durabilité.

Qualität
Quality
La qualité

Wir tun alles dafür unseren Kunden ein hochwertiges und sicheres Produkt zur Verfügung zu stellen. Siku Spielzeug besteht meistens aus einer Mischung aus Metall und robustem Kunststoff. Wir produzieren und entwickeln auf allerhöchsten Qualitätsstandards, damit der Freude am Produkt nichts im Wege steht.

We do our utmost to offer our customers safe, high-quality products. Siku toys are made of high-quality materials, such as a mixture of metal and robust plastic. We produce and develop our toys to the very highest quality standards so that nothing gets in the way of enjoying our products.

Nous faisons tout notre possible pour proposer à nos clients des produits d'excellente qualité et sûrs. Les jouets Siku sont fabriqués avec d'excellents matériaux tels que par exemple l'alliance de métal et de plastique résistant. Notre production et notre développement répondent aux plus hauts standards afin que rien ne vienne entraver le plaisir de jouer.

Kompatibilität
Compatibility
Compatibilité

Kinder erschaffen sich ihre eigene Welt. Uns ist wichtig, dass die Phantasie des Kindes nicht eingeschränkt wird. Deshalb legen wir großen Wert darauf, dass unsere Produkte kompatibel sind. Zum Beispiel unsere Anhängerkupplungen bei den Fahrzeugen, unsere SIKUWORLD Gebäude oder die Toddys untereinander – immer mit dem Ziel, Kreativität anzuregen.

Children create their own world. It is important to us to inspire children's imaginations. This is why we place great emphasis on the compatibility of our products. Examples include the trailer hitches on our vehicles, our SIKUWORLD buildings and the Toddys – always with the aim of stimulating creativity.

Les enfants créent leur propre monde. Pour nous, la stimulation de l'imagination des enfants tient un rôle crucial. Nous attachons donc une grande importance à ce que nos produits soient compatibles. C'est, à titre d'exemple, le cas pour les crochets de remorque de nos véhicules, nos constructions SIKUWORLD et les Toddys entre eux, afin de stimuler la créativité.

Nachhaltigkeit
Sustainability
Durabilité

Siku Spielzeug ist nachhaltig, weil es von einer Generation zur nächsten weitergegeben werden kann. Aufgrund der guten Qualität ist es über Jahrzehnte beispielbar.

Siku toys are sustainable because they can be passed on from one generation to the next. Thanks to the good quality, it can be played with for decades.

Les jouets Siku sont durables car ils peuvent être transmis d'une génération à l'autre. En raison de la bonne qualité, ils peuvent être joués pendant des décennies.

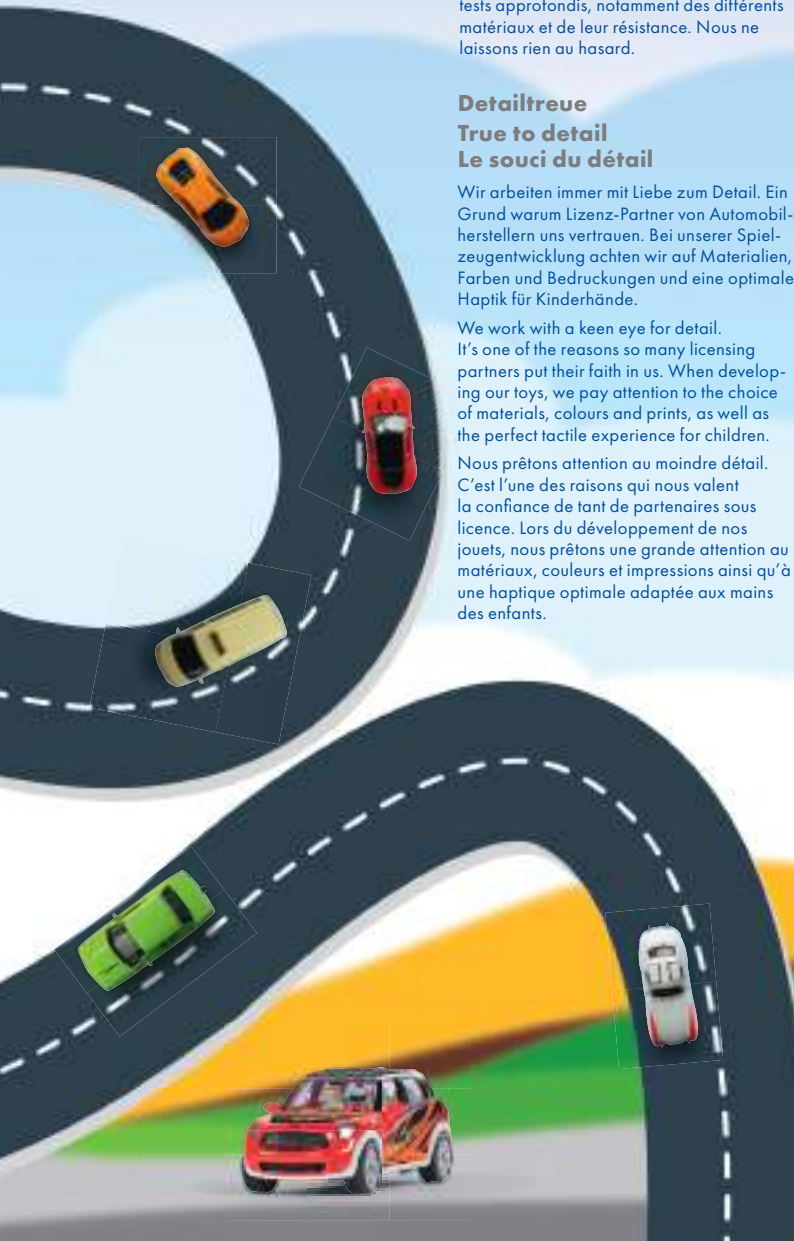



1-5

Verschiedene Spielstufen für Kinder von 1-5 Jahren

Different play levels for children from 1-5 years

Différents niveaux de jeu pour les enfants de 1 à 5 ans



Hochwertiger Friktionsmotor

High-quality friction motor

Moteur à friction de qualité supérieure



Light & Sound in vielen Toddys mit on/off-Schalter

Light & Sound in many Toddys with on/off switch



Beaucoup de Toddys équipés de son et lumière avec bouton marche/arrêt



Kompatibel mit Bausteinen anderer Hersteller

Compatible with building bricks from other manufacturers

Compatible avec des briques d'autres fabricants

Click
★
Play!



1

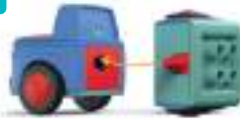

2



3



Paula Pretty

Mike Moby

Conny Cloudy

Zoe Zoomy

Jim Jumpy

Mio Mounty

Sam Speedy

Olli Oldy

Dave Divey

Anna Amby



Barcode: 4 201475 100123

Icons: Motor, Lights, Sound

Luke Loady



Barcode: 4 201475 100124

Icon: Motor

Harry Helpy



Barcode: 4 201475 100125

Icons: Motor, Lights, Sound

Bill Breezy



Barcode: 4 201475 100126

Icons: Motor, Lights, Sound

Betty Blinky



Barcode: 4 201475 100127

Icon: Motor

Frank Farmy



Barcode: 4 201475 100128

Icon: Motor



bambino LÜK

709700000

bambinoLÜK-Set
Meine Toddys
- Logisches Denken

Barcode: 4 201475 100129

Willy Worky



Barcode: 4 201475 100130

Icon: Motor

Freddy Fluxy



Barcode: 4 201475 100131

Icon: Motor

Chris Carry



Barcode: 4 201475 100132

Icons: Motor, Lights, Sound

Adam Addy



Barcode: 4 201475 100133

Icon: Motor

Tom Trusty



Barcode: 4 201475 100134

Icons: Motor, Lights, Sound

Leo Loopy



Barcode: 4 201475 100135

Icons: Motor, Lights, Sound



Barcode: 4 201475 100136

Lina



Barcode: 4 201475 100137

Lotty



Barcode: 4 201475 100138

Bob



Barcode: 4 201475 100139

Benny



Barcode: 4 201475 100140

Toddys



toddys.official



toddys



LIZENZEN · LICENCES

Unsere Lizenzpartner

Wir sind stolz auf unsere zahlreichen Lizenzen, denn diese machen unsere Fahrzeuge zu kleinen Originalen.

Our licencing partners

We are proud of our many licences, as these make our vehicles into small originals.

Nos partenaires sous licence

Nous sommes fiers de nos nombreuses licences car elles confèrent à nos véhicules une touche d'originalité unique.



NEUHEITEN

NOVELTIES

NOUVEAUTÉ



NEU

<p>SIKUSUPER</p> <p>107000011 VW Multivan</p>    <p>with many stickers</p>  <p><small>Sipek GmbH, Schillerhöhe Str. 61, D-55511 Lutzerath Eisenberg, Germany / Allemagne www.siku.de 50024862</small></p>	<p>129500000 Planierraupe Bulldozer</p>   	<p>158500000 VW Transporter</p>   
<p>150800003 Bugatti Chiron</p>   	<p>155100000 BMW Polizeimotorrad BMW Police motorbike BMW Moto de police</p>   	<p>155200000 Polizei Einsatzfahrzeug Police patrol car Véhicule d'intervention police</p>   
<p>158400000 Dodge Challenger SRT County Sheriff</p>   	<p>168500002 LKW mit Kippmulde und Anhänger Truck with dumper body and tipping trailer Camion avec benne basculante et remorque à benne basculante</p>    	
<p>189600003 Fahrmischer Mixer truck Camion toupie 139x75x44 mm 5.5x3.0x1.7"</p>   	<p>236000000 Nissan Navara 155x75x65 mm/ 6.1x3.0x2.6"</p>   	

SIKUFARMER

<p>207000000 Volldrehpflug Reversible Plough Charrue brabant 255x97x66 mm/ 10.0x3.8x2.6"</p>   	<p>207100000 Scheibenegge Disc Harrow Herse circulaire repliable 255x131x58 mm/ 10.0x5.2x2.3"</p>   
---	---

NEW
2/24

NEW ITEMS · NOUVEAUTÉS · SIKUNEUHEITEN

siku

SIKUCONTROL

688500000

Massey Ferguson 95 mit Bluetooth App Steuerung ohne Fernsteuermodul
with Bluetooth App-Control w/o remote control unit
avec commande par application Bluetooth
250x151x102 mm / 9.8x5.9x4.0"



NEW
2/24



Bluetooth®



4 LED	AAA AAA AAA	LED	LED	proportional	proportional	2
-------	-------------	-----	-----	--------------	--------------	---

*kompatibel mit 6730
*compatible with 6730
*compatible avec 6730

SYMBOLE • SYMBOLS • SYMBOLES

NEW
1/24

1. Halbjahr der Neuheitenauslieferung
Novelties of 1st half year
Sortie des nouveautés 1^{er} semestre

Wechselbare Räder
Exchangeables wheels
Roues échangeables

Schwimmfähig
Floatable
Flottable

Federung
Suspension
Suspension

Mit Wasser befüllbar
Can be filled with water
Possibilité de remplissage avec de l'eau

Türen zum Öffnen
Opening doors
Portes ouvrables

Zum Ankuppeln
For coupling
Pour attelage

NEW
2/24

2. Halbjahr der Neuheitenauslieferung
Novelties of 2nd half year
Sortie des nouveautés 2^{ème} semestre

WORLD-Artikel ist erweiterbar
WORLD item can be extended
Les articles WORLD sont modulaires

Licht- und Soundmodul
light and sound device
Son et lumière

Blisterkarte
Blister card
Blister

NEU

SIKUSUPER

154600000
Jeep Wrangler Safari



155800000
BMW i8



153200000
BMW M3 Coupé
Polizei
Police



155700000
VW Käfer
VW Beetle
VW Coccinelle



170200000
DHL Frachtflugzeug mit Zubehör
DHL Cargo aircraft with accessories
DHL avion cargo avec accessoires
395x385x100 mm/ 15.6x15.2x3.9"



236200000
VW T1 Transporter
155x75x65 mm/6.1x3.0x2.6"



272200000
Abschleppwagen
Breakdown truck
Dépanneuse
210x87x54 mm/ 8.3x3.4x2.1"



NEU

SIKUFARMER

322400000

Weihnachtstraktor

Christmas tractor

Tracteur Noël

250x151x102 mm / 9.8x5.9x4.0"

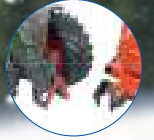

NEU

SIKUSUPER

353900004

Fahrmischer

Mixer truck

Camion toupie

235x115x65 mm / 9.2x4.5x2.6"



373600004

Gelenkbus

Articulated bus

Bus à soufflet

405x97x65 mm / 16x3.8x2.6"



SIKUSUPER

394400000

Autotransporter

Car transporter

Camion porte-voitures

460 x 120 x 72 mm / 18.1x4.7x2.8"



NEU



DIE STARS IN JEDEM KINDERZIMMER.

**THE STARS IN EVERY
CHILD'S ROOM.**

**LES ÉTOILES DANS CHAQUE
CHAMBRE D'ENFANT.**



BLISTER



Style my siku

Bastelset

Construction kit

Set de bricolage

650300000

Bastelset Fiat 500 „Prinzessin“
 Craftwork model Fiat 500 „Prinzessin“
 Set de bricolage Fiat 500 „Prinzessin“
 139x75x44 mm / 5.5x3.0x1.7"



with
many
stickers



650400000

Bastelset MINI Countryman
 Craftwork model
 Set de bricolage
 139x75x44 mm / 5.5x3.0x1.7"



with
many
stickers



650500000

Bastelset VW T5 „Snowman“
 Craftwork model „Snowman“
 Set de bricolage „Snowman“
 139x75x44 mm / 5.5x3.0x1.7"



with
many
stickers





BLISTER

650600000

Bastelset Fiat 500 „Adventure“
 Craftwork model Fiat 500 „Adventure“
 Set de bricolage Fiat 500 „Adventure“
 139x75x44 mm / 5.5x3.0x1.7"



with
many
stickers



650700000

Bastelset MINI Countryman
 Craftwork model
 Set de bricolage
 139x75x44 mm / 5.5x3.0x1.7"

Summer's



with
many
stickers



650900000

Bastelset VW T5 „Astronaut“
 Craftwork model „Astronaut“
 Set de bricolage „Astronoute“
 139x75x44 mm / 5.5x3.0x1.7"



with
many
stickers





080100001
Bagger
 Excavator
 Excavatrice



080200001
Frontlader
 Front loader
 Tracto-pelle



080400005
Polizeibus
 Police van
 Fourgon de police



080500005
Krankenwagen
 Ambulance



080700002
Polizei-Hubschrauber
 Helicopter
 Hélicoptère





081300004
Betonmischer
 Cement mixer
 Toupie



081100005
Müllwagen
 Refuse truck
 Camion poubelle





081700002
Space-Shuttle
 Navette spatiale



082800006
Recycling-Transporter
 Camion de recyclage



084700001
Massey Ferguson
 Traktor
 Tracteur



085600001
Rettungshubschrauber
 Helicopter
 Hélicoptère



085700003
Verkehrszeichen
 Road signs
 Signaux routiers





086600013
SIKUSNIPEr



086700009
SIKURANGER



087500008
SIKUSTORM

089400000
Internationale Verkehrszeichen
 International Road Signs
 Signaux routiers internationaux



089500000
Straßenwalze
 Compactor
 Rouleau-compresseur



98 x 78 mm
3.9 x 3.1"

SIKUSUPER siku



100700013
BMW 645i Cabrio
Convertible
Cabriolet



101100002
Straßenbahn
Tram



101300003
Nahverkehrsbus
Local train
Train de banlieue



101500004
Feuerwehdrehleiter
Fire engine
Echelle de pompiers



102100005
Linienbus
City bus
Bus urbain



103000000
Claas Axion 950



103400004
Tanklöschfahrzeug
Fire engine
Camion de pompiers



103700003
Pistenbully



105700001
Buggy



106300000
Fendt 1050 Vario



106400000
John Deere* 6215R



107500004
LKW mit Kippmulde
Truck with dumper body
Camion benne



107700001
2-Achs-Anhänger
4-wheel trailer
Remorque 2 essieux



107900001
Polizei Wasserwerfer
Police water cannon
Canon à eau de la police



108000001
Feuerwehr Hubrettungsstufe
Firefighter elevating rescue platform
Camion pompiers à bras éleveurs articulés



108100000
DEUTZ-FAHR TTV
7250 Agrotion



108500006
Postwagen
Post van
Camionnette postale



109100000
New Holland T7.315



109900000
Wasserflugzeug
Seaplane
Hydravion

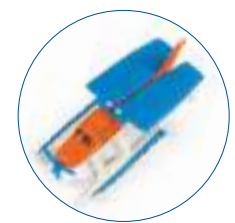
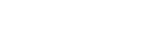

*John Deere Produkte sind nicht in allen Ländern erhältlich. · John Deere products are not available in all countries. · Les produits John Deere ne sont pas disponibles dans tous les pays.

110100000

Sportflugzeug
Sports aircraft
Avion sportif



+16
Sticker



110300000

Baggerlader
Backhoe loader
Chargeuse-pelleteuse



110400000

Kehmaschine
Sweeper
Balayeuse



110500000

Maulx X540
rot
red
rouge



110600000

Maulx X540
pink



110700000

LKW mit Kofferaufbau Sixt
Truck with box body Sixt
Camion avec caisse Sixt



129600000

Vespa 125 GTS Super



129800000

LKW mit Absetzmulde
Truck with skip
Camion benne



130900003

Winterdienst
Winter service truck
Chasse neige



131100001

Gabelstapler
Forklift truck
Gerbeuse à fourche



131600002

Audi R8 Spyder



131900003

US-Schulbus
US school bus
Bus scolaire américain



98 x 78 mm
3.9 x 3.1"

SIKUSUPER

siku

132100002

Doppelstock Reisebus
Double decker bus
Bus à impériale



132200003

LKW mit Verkehrszeichen
Road maintenance truck
Camion de signalisation



134200010
Jeep Wrangler



132600004

Hydraulischer Kranwagen
Hydraulic crane truck
Grue hydraulique

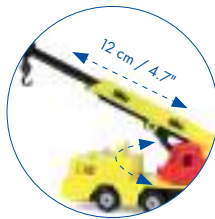

135000003

Polizei-
Mannschaftswagen
Police team van
Fourgon de police



135700003

Rennwagen
Racing car
Voiture de course



136000010

Großraumtaxi
Taxi van
Taxi navette



138400001

KTM 1290
Super Duke R



138500000

Ducati Panigale 1299



139100001

KTM SX-F 450



139900000

BMW R 1250 GS LCI



139200000

Claas Axion mit Frontlader
with front loader
avec chargeur frontal



139300000

Fendt 1050 Vario mit Frontlader
with front loader
avec chargeur frontal



139400000

DEUTZ-FAHR mit Frontlader
with front loader
avec chargeur frontal



139500000

John Deere* mit Frontlader
with front loader
avec chargeur frontal



139600000

New Holland mit Frontlader
with front loader
avec chargeur frontal



139700000

DEUTZ-FAHR
TTV 7250 Warrior































































BLISTER

<p>14080001 Dodge Challenger SRT Hellcat</p>   	<p>14180002 Claas Maishäcksler Forage harvester Ensileuse à maïs</p>   	<p>14490001 Lamborghini Aventador LP 700-4</p>  	
<p>14530002 Fiat 500</p>   	<p>14580000 BMW i8</p>  	<p>14600007 Feuerwehr Einsatzleitwagen Fire command car Voiture de pompiers</p>   	<p>14610003 Notarzt-Einsatz- Fahrzeug Emergency car Ambulance</p>   
<p>14690005 ADAC Pick-Up</p>   			
<p>14750001 Porsche 918 Spyder</p>  	<p>14760001 Claas Mähdrescher Combine harvester Moissonneuse-batteuse</p>   	<p>14770000 Liebherr Radlader Four wheel loader Chargeuse sur pneus</p>   	
<p>14820000 Manitou Teleskoplader Telehandler Chariot télescopique</p>   	<p>14840001 Massey Ferguson mit Frontlader with front loader avec chargeur frontal</p>   		
<p>14850004 Lamborghini Veneno</p>  	<p>14860001 Bergmann Dumper</p>  	<p>14880002 VW The Beetle pink</p>    <div data-bbox="1165 1926 1508 2139"> <p>+ 15 Sticker</p>  <p><small>Siper GmbH, Schiltbacher Str. 60, D-98511 Lößnitzsdorf Duisland / Germany / Allemagne www.siku.de 1488/ 621300602</small></p> </div>	

98 x 78 mm
3.9 x 3.1"

SIKUSUPER



siku

<p>148900002 Kia Sorento</p>   	<p>150200000 Taxi</p>   	<p>150400000 Polizei- Streifenwagen Police patrol car Voiture de patrouille</p>   	<p>150500001 VW The Beetle Cabrio Convertible Cabriolet</p>   
<p>150600000 Porsche 911 Turbo S</p>   	<p>150700000 Bentley Continental GT V8 Convertible</p>   	<p>150900000 BMW 750i</p>   	<p>152000000 Jaguar F-Type R</p>   
<p>152100000 Range Rover</p>   	<p>152300000 Porsche 911 Turbo S Cabriolet Convertible Cabriolet</p>   	<p>152400000 Claas Torion 1914 Radlader Wheel loader Chargeuse sur pneus</p>  	<p>152500000 Chevrolet Corvette ZR1 Polizei Police</p>   
		<p>152600000 Ford GT</p>  	<p>152700002 Apollo IE</p>   
<p>152900001 Mercedes-AMG GT4</p>  	<p>153000000 Ford Mustang GT</p>   	<p>153100000 Lotus Elise</p>  	<p>153300000 BMW i8 US Police</p>  
<p>153400001 Chevrolet Corvette ZR1</p>   	<p>153500001 Ford F150</p>   	<p>153600002 Rettungswagen Ambulance</p>  	<p>153700001 McLaren Senna</p>  

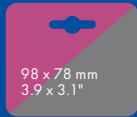
BLISTER



BLISTER

<p>153900000 Fendt mit Ballenzange with bale gripper avec pince à balles</p> 	<p>154000000 John Deere* mit Baumstammgreifer with log grabber avec pince à bois</p> 	<p>154400000 New Holland mit Palettengabel und Palette with pallet fork and pallet avec fourche à palettes et palette incluse</p> 	
<p>153800001 Chevrolet Camaro</p> 	<p>154100000 Bugatti Chiron Gendarmerie</p> 	<p>154200001 Mercedes-Benz SLS AMG Black Series</p> 	<p>154300000 Volvo FH16 Performance</p> 
<p>154500000 Chevrolet Corvette ZR1 Police</p> 	<p>154900000 Land Rover Defender 90 P400 AWD</p> 	<p>156500000 Audi Q4 e-tron ADAC Pannenhilfe Breakdown car Dépanneuse</p> 	<p>156600000 Ford Mustang Mach-E 1400</p> 
<p>156700000 Audi Q4 e-tron</p> 	<p>156800000 Land Rover Defender Feuerwehr Fire command car Pompier</p> 	<p>156900000 Land Rover Defender Bundespolizei Federal police Germany Police fédérale allemande</p> 	<p>157100000 Lamborghini Sian Roadster</p> 
<p>157200000 Dodge Challenger SRT Hellcat "Custom"</p> 	<p>157700000 Aston Martin Vantage GT4</p> 	<p>157800000 Toyota GR Supra</p> 	<p>157900000 Nissan GT-R Nismo</p> 
<p>158000001 Audi RS 5 Racing</p> 	<p>158100000 BMW M4 Racing 2016</p> 	<p>158200000 Aston Martin DBS Superleggera</p> 	<p>158300000 Piaggio Ape 50</p> 



16050000

Fendt mit Krampe Muldenkipper
Fendt with Krampe tipping trailer
Fendt avec benne basculante Krampe



16060000

DEUTZ-FAHR mit Fortuna 2-Achs Anhänger
DEUTZ-FAHR with Fortuna 4-wheel-trailer
DEUTZ-FAHR avec remorque Fortuna à 2 essieux



16100003

Tieflader mit Helikopter
Low loader with helicopter
Camion surbaissé avec hélicoptère



161100002

Tieflader mit Bagger
Low loader with excavator
Camion surbaissé avec excavatrice



161400001

Tieflader mit Rakete
Low loader with rocket
Camion surbaissé avec fusée



161300002

Tieflader mit Boot
Low loader with boat
Camion surbaissé avec bateau



161500010

Straßenbahn
Tram



161600002

Tieflader mit Frontlader
Low loader with front loader
Surbaissé avec chargeur frontal



161700006

Gelenkbus
Articulated Bus
Bus à soufflet



162300003

MEGA LIFTER

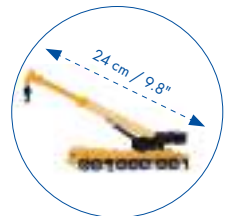

BLISTER

162400005

MAN Reisebus
Coach
Bus de tourisme
1:87



162600003

Tanksattelzug
Articulated tank truck
Citerne semi-remorque
1:87



162700009

Koffer-Sattelzug
Articulated truck with trailer
Camion cabine
1:87



162900004

PKW mit Wohnanhänger
Car with trailer caravan
Voiture avec caravane



163600005

Unimog Feuerwehr mit Boot
Fire engine with boat
Pompier avec bateau



164500003

Traktor mit Forstanhänger
Tractor with forestry trailer
Tracteur avec remorque forestière



164600003

Nahverkehrszug
Local train
Train de banlieue
1:120



164700005

Helikopter
Helicopter
Hélicoptère
1:87



165000002

Claas mit Silagewagen
with silage trailer
avec remorque d'ensilage



165100004

Jeep mit Pferdeanhänger
with horse trailer
avec remorque à chevaux



165200001

John Deere* Harvester
1:87



165800007

Jeep mit Boot
with boat
avec bateau





165900002
Holz-Transport-LKW
 Log transporter
 Camion forestier
 1:87





166500001
John Deere * mit Ballenpresse
 with round baler
 avec presse à ballots





166700005
Abschleppwagen mit PKW
 Breakdown truck with van
 Dépanneuse avec voiture





166800001
Traktor mit Feldspritze
 Tractor with crop sprayer
 Tracteur avec épandeur





167100006
Niesmann + Bischoff Arto
 Wohnmobil
 Camper van
 Camping-car





167200004
Steyr mit Pöttinger Mähwerkskombination
 with Pöttinger mower combination
 avec combinaison de faucheuses Pöttinger





167300001
Traktor mit Universalstreuer
 Tractor with universal manure spreader
 Tracteur avec épandeur universel





167700001
Traktor mit Bewässerungshaspel
 Tractor with irrigation reel
 Tracteur avec rouleau d'irrigation





167900000
Argo Avenger mit Anhänger
 with trailer
 avec remorque





168300000
Volvo Abrollkipper mit Kran
 Roll-off tipper with crane
 Camion polybenne grue
 1:87





BLISTER

*John Deere Produkte sind nicht in allen Ländern erhältlich. · John Deere products are not available in all countries. · Les produits John Deere ne sont pas disponibles dans tous les pays.

BLISTER

168600001
HS Schoch 8x8 MAN Truck Trial
1:87



168700000
Kommunal Set Kehrmaschine und Müllwagen
Municipal set Sweeper and Refuse truck
Coffret communal poubelle et balayeuse



168900000
Transporthubschrauber
Transport helicopter
Hélicoptère de transport



169000001
LKW mit Tankwagenaufbau und Anhänger
Truck with tank truck superstructure and trailer
Camion-citerne et remorque



169200002
Baustellen-Set
Construction set
Set de construction



169300001
Ford F150 Pick-Up Camper



169400001
LKW mit Anhänger DHL
Truck with trailer DHL
Camion avec remorque DHL



169500000
LKW mit Absetzmulde und Anhänger
Truck with skip and trailer
Camion benne avec remorque



169600000
Buggy mit Sportflugzeug
Buggy with sporting airplane
Buggy avec avion sportif



... immer ein tolles Geschenk
 ... always a great gift
 ... toujours un super cadeau



BLISTER

630400001

Geschenkset Landwirtschaft

Gift set agriculture

Coffret cadeau agricole

296x110x48 mm / 11.7x4.3x1.9"



4 006874 063040



632500001

Freizeitset

Leisure set

Set de loisirs

296x110x48 mm / 11.7x4.3x1.9"



4 006874 063250



632800001

Supercars Set

Gift set Supercars

296x110x48 mm / 11.7x4.3x1.9"



4 006874 063280



BLISTER

632900001

Geschenkset Straßenbau

Gift set road construction
Coffret cadeau construction routière
296x110x48 mm / 11.7x4.3x1.9"



633100000

Geschenkset Race

Gift set Race
Coffret cadeau course
296x110x48 mm / 11.7x4.3x1.9"



633000001

Geschenkset Feuerwehr

Gift set fire brigade
Coffret cadeau pompiers
296x110x48 mm / 11.7x4.3x1.9"



633200000

Geschenkset Rettung

Gift set rescue
Coffret cadeau secours
296x110x48 mm / 11.7x4.3x1.9"



633500000

DHL Logistik Set

DHL Logistics set
Coffret logistique DHL
296x110x48 mm / 11.7x4.3x1.9"



633600000

Geschenkset Baustelle

Gift set construction site
Coffret cadeau construction
296x110x48 mm / 11.7x4.3x1.9"



631400000

Cabrio Set
Convertible set
Set de voitures Cabriolets
170x57x100 mm /
6.7x2.2x3.9"



632300000

Sportwagen Set
Sports cars set
Set de voitures de sport
170x57x100 mm /
6.7x2.2x3.9"



631200001

Flughafen Set
Airport set
Set Aéroport
355x210x60 mm
14.0x8.8x2.4"

15
Parts



mit 5m Tape
with 5m tape
avec 5m bande



BLISTER

632400002

Geschenkset DHL
Gift set DHL
Coffret cadeau DHL
240x70x100 mm /
9.4x2.8x3.9"



632600001

Notruf Set
Emergency set
Set d'urgence
170x70x100 mm / 6.7x2.8x3.9"



Displaykarton · Display box · Boîte d'assortiment
295x305x120 mm / 11.6x12.0x4.7"

600800006

50 Stück Art.-Gr. 08 sortiert
50 pcs group 08 assorted
50 pcs groupe 08 assorties



601000012

50 Stück Art.-Gr. 10 sortiert
50 pcs group 10 assorted
50 pcs groupe 10 assorties



610800006*

50 Stück Art.-Gr. 08 sortiert
50 pcs group 08 assorted
50 pcs groupe 08 assorties



611000006*

50 Stück Art.-Gr. 10 sortiert
50 pcs group 10 assorted
50 pcs groupe 10 assorties



611300008*

50 Stück Art.-Gr. 13 sortiert
50 pcs group 13 assorted
50 pcs groupe 13 assorties



Displaykarton · Display box · Boîte d'assortiment
390x280x125 mm / 15.4x11.0x4.9"

601600005

25 Stück Art.-Gr. 16 sortiert
25 pcs group 16 assorted
25 pcs groupe 16 assorties



611600005*

25 Stück Art.-Gr. 16 sortiert
25 pcs group 16 assorted
25 pcs groupe 16 assorties



*Alle Artikel mit einheitlicher Art.- und EAN-Nummer
*All models with the same item no. and EAN-code
*Tous les modèles ont une référence et un code EAN unique.

KLEINE WELT – GANZ GROß

Jetzt das Lieblingsmodell finden.

SMALL WORLD – PRETTY BIG

Find your favourite model now.

PETIT UNIVERS – TOUT GRAND

Choisis dès à présent ton modèle préféré.



1:1000
1:1400



172000001

Kreuzfahrtschiff AIDA

Cruiselinier

Bateau de croisière

1:1400

226x75x54 mm / 9.0x3.0x2.0"



172800000

Tallink Megastar

1:1000

260x75x48 mm / 10.2x2.9x1.9"



172900000

Silja Symphony

1:1000

260x75x48 mm / 10.2x2.9x1.9"



173000001

Mein Schiff 1

1:1400

280x75x42 mm / 11.0x3.0x1.7"



174900001

Magirus Multistar TLF mit Teleskopmast
with telescopic mast
avec bras télescopique
175x87x42 mm / 6.8x3.4x1.6"

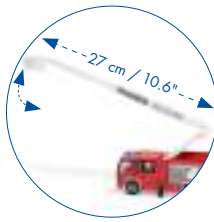

178900000

JCB® 457 WLS Radlader
Wheel loader
Chargeuse sur pneus
156x75x48 mm / 6.1x3.0x1.9"

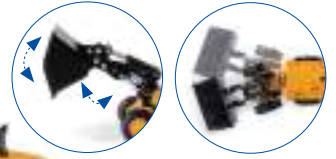

179000000

MAN LKW mit Tieflader und JCB® Radlader
MAN truck with low loader and JCB® wheel loader
MAN camion surbaissé avec chargeuse JCB®
260x75x48 mm / 10.2x2.9x1.8"



179100000

Doppelstock-Zug
Double-deck train
Train à deux étages
250x75x42 mm / 9.8x2.9x1.6"

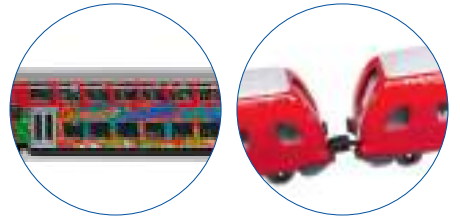

179600000

LKW mit Kippsattel und Dach
Truck with trailer and roof
Camion avec benne basculante et toit
210x75x54mm / 8.2x2.9x2.1"

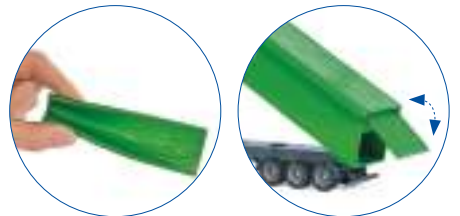

180600002

DHL Road Train
DHL Train routier
440x75x48mm / 17.3x3.0x1.9"



40,5 cm / 15.9"

179800000

Liebherr R9800 Mining-Bagger

Mining excavator

Pelle mécanique de mine

340x161x115 mm / 13.4x6.3x4.5"



←----- 27 cm / 10.6" -----→

180700001

Liebherr T 264 Muldenkipper

Mining truck

Tombereau

210x131x103 mm / 8.3x5.2x4.1"



←----- 17 cm / 6.7" -----→

184100003

Feuerwehdrehleiter

Fire engine

Echelle de pompiers

156x75x48 mm / 6.1x3.0x1.9"

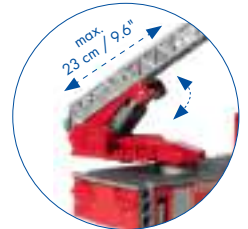

max.
23 cm / 9.6"

184700003

Schwertransporter mit Tiefbettauflieger

Heavy haulage transporter with flat-bed trailer

Camion de transport lourd avec surbaissé

320x105x59 mm / 12.6x4.1x2.3"



←----- 26,5 cm / 10.4" -----→

184900001

Schwertransport mit Yacht

Heavy haulage transporter with yacht

Surbaissé avec yacht

305x151x71 mm / 12.0x6.0x2.8"



185900002

Teleskop-Kranwagen

Telescopic crane truck
Grue télescopique
156x75x48 mm / 6.1x3.0x1.9"

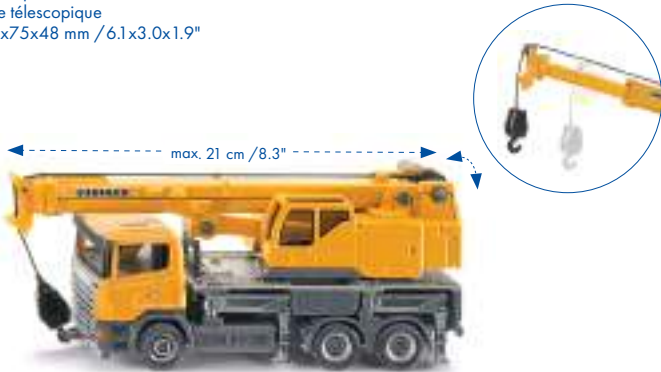

187400003

LIEBHERR-Hydraulikbagger

Hydraulic excavator
Pelle hydraulique
260x75x57 mm / 10.3x3.0x2.3"



187700002

Volvo Dumper

170x75x54 mm / 6.7x3.0x2.1"



188400002

MAN Doppelstock Linienbus

Double decker city bus
Bus urbain à impériale
210x75x54 mm / 8.3x3.0x2.1"



188600005

Mobilkran Liebherr

Mobile crane
Grue mobile
255x97x66 mm
10.0x3.8x2.6"

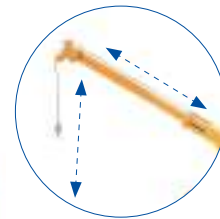
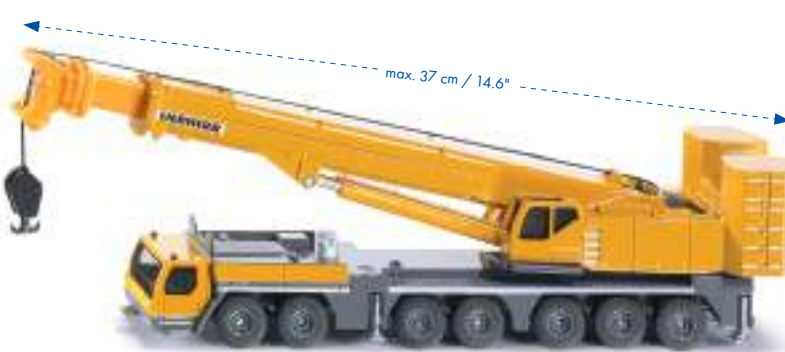

189000003

Müllwagen

Refuse truck
Camion poubelle
170x75x54 mm
6.7x3.0x2.1"

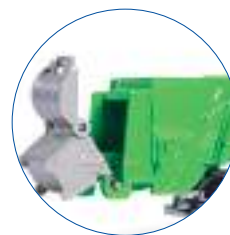

SUPER



189100003
Seilbagger
 Cable excavator
 Pelle à câbles
 240x220x65 mm /
 9.4x8.7x2.5"

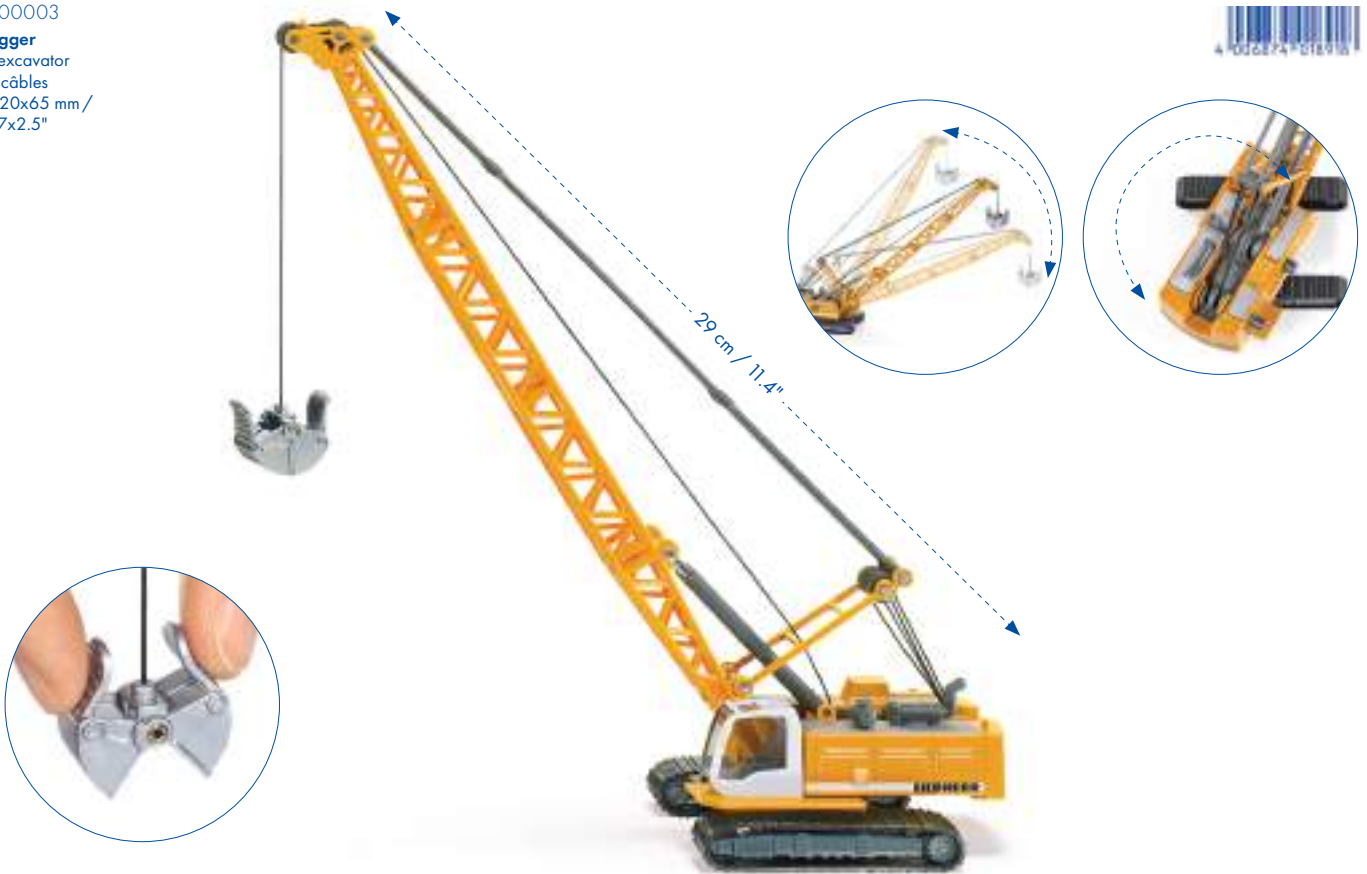

SUPER

189500003
Straßenbahn
 Tram
 280x75x42 mm / 11.0x3.0x1.6"



189700003
Pistenbully
 155x75x85 mm / 6.1x3.0x3.3"



189800002
Winterdienst
 Winter service truck
 Chasse-neige
 155x75x65 mm
 6.1x3.0x2.6"



172200002

Gabelstapler

Forklift truck
Gerbeuse à fourche
139x87x51 mm / 5.5x3.4x2.1"



192000002

Mercedes-Benz Sprinter DHL Paketdienst

DHL Parcel Service
Service colis DHL
175x87x59 mm / 6.9x3.4x2.3"

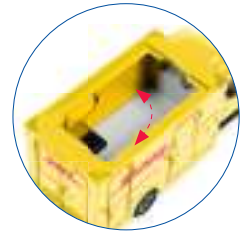

192200001

VW T6 California

mit beweglichem Dach und Zubehör
with movable roof and accessories
avec toit amovible et accessoires
155x87x51 mm / 6.1x 3.4x2"



192600000

Geldtransporter

Money transporter
Transporteur de fonds
175x97x71 mm / 6.8x3.8x2.7"



+ Sticker



+ Cardboard sheets

SUPER

194100000
Streetscooter BIO Lieferdienst
 Organic Fresh Delivery Service
 Service de livraison Bio
 175x97x71 mm / 6.8x3.8x2.7"



+
Cardboard sheets



+
Sticker

199700002
MAN LKW mit Kofferaufbau, Ladebordwand und Gitterbox
 MAN Truck with box body and tail lift
 Camion MAN porte-caisse avec hayon élévateur
 277x105x70 mm / 10.9x4.1x2.7"

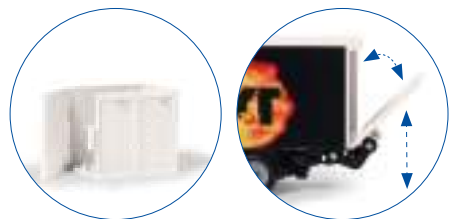

194400000
Streetscooter
 139x87x51 mm / 5.5x3.4x2"



SUPER

211000002

Kranwagen

Mobile crane

Camion-grue

290x115x59 mm / 11.4x4.5x2.3"



←-----max. 55 cm / 21.7"-----→

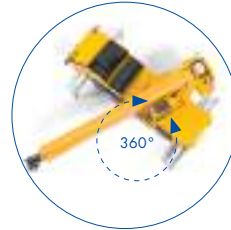

SUPER



211300000

Mercedes-Benz Sprinter 6x6 Feuerwehr
 Fire engine
 Pompiers
 175x87x59 mm / 6.9x3.4x2.3"



211400001

MAN Feuerwehr Drehleiter
 MAN Aerial ladder
 Echelle de pompiers MAN
 260x105x70 mm / 10.2x4.1x2.7"

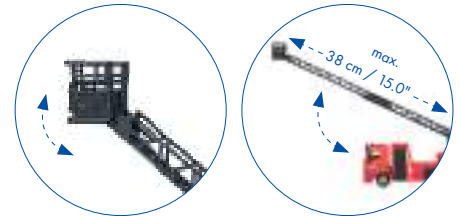

211500001

Mercedes-Benz Sprinter Miesen Typ C Rettungswagen
 Type C Ambulance
 Ambulance de type C
 175x87x59 mm / 6.9x3.4x2.3"



211600001

VW T6 Notarzwagen
 Emergency Car
 Ambulance
 155x87x51 mm / 6.1x 3.4x2"



+ Sticker



211700000

Feuerwehr Arbeitsboot
 Fire brigade working boat
 Bateau pompiers
 255x115x88mm / 10x4.5x3.5"

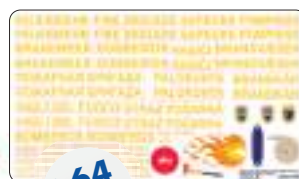

+ 64 Sticker





230100000
Mercedes-Benz Sprinter Polizei
 Police
 175x87x59 mm / 6.9x3.4x2.3"

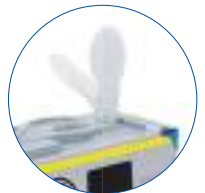

230200000
Mercedes-Benz E-Klasse All Terrain 4x4² Polizei
 Mercedes-Benz E-Class All Terrain 4x4² Police
 Mercedes-Benz Classe E All Terrain 4x4² Police
 155x75x65 mm/6.1x3.0x2.6"



230300001
BMW i8 Polizei
 Police
 155x75x65 mm / 6.1x3.0x2.6"



230400000
Rheinmetall MAN Survivor R
 175x87x59 mm / 6.9x3.4x2.3"



230500001
Mercedes-Benz Sprinter Bundespolizei
 German Federal police
 Police fédérale allemande
 175x87x59 mm / 6.9x3.4x2.3"



230600002
Mercedes-AMG G65 Feuerwehr
 Fire command car
 Pompiers
 155x75x65 mm / 6.9x3.4x2.3"



230700001
GHE-O Rescue
 155x75x65 mm / 6.1x2.3x2.6"



230800002
Mercedes-AMG G65 Bundespolizei
 German federal police
 Police fédérale allemande
 155x75x65 mm / 6.1x2.3x2.6"



230900003
RAM 1500 US-Polizei
 US Police
 Police américaine
 155x75x65 mm / 6.1x2.3x2.6"



234700000
BMW Z4 M40i
 155x75x65 mm/6.1x3.0x2.6"



+ 12
 Sticker



234800001
BMW i8 LCI
 155x75x65 mm/6.1x3.0x2.6"



doors
PATENTED
 doors



234900001
Mercedes-Benz E-Klasse All-Terrain 4x4²
 Mercedes-Benz E-Class All-Terrain 4x4²
 Mercedes-Benz Classe E All-Terrain 4x4²
 155x75x65 mm/6.1x3.0x2.6"



235000002
Mercedes-AMG G65
 155x75x65 mm/6.1x2.3x2.6"

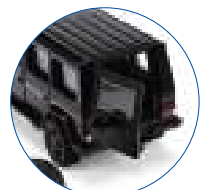

SUPER

235700000
Vision Mercedes-Maybach 6
 155x75x65 mm/6.1x3.0x2.6"



235800001
RAM 1500 mit Ballonreifen
 with ballon tyres
 à pneus ballon
 176x87x65 mm/7x3.4x2.6"



235900000
Chevrolet Corvette Stingray
 155x75x65 mm/6.1x3.0x2.6"



236100000
VW T1 Bus
 155x75x65 mm/6.1x3.0x2.6"



236300000
VW T1 Transporter Custom
 155x75x65 mm/6.1x3.0x2.6"



252600000

Geschäftsflugzeug

Business aircraft

Avion d'affaires

320x254x83 mm / 12.5x10x3,3"



SUPER

252700001

Transporthubschrauber

Transport helicopter

Hélicoptère de transport

410x131x100 mm / 16.1x5x4"



253900001

Rettungs-Hubschrauber

Rescue helicopter

Hélicoptère

premiers secours

235x97x59 mm / 9.3x3.8x2.3"



254200003**PKW mit Wohnwagen**

Car with caravan

Voiture avec caravane

1:55

255x115x59 mm /10.0x4.5x2.3"

**254300003****PKW mit Motorboot**

Car with motorboat

Voiture avec bateau

1:55

340x97x51 mm /13.4x3.8x2.0"

**254400007****PKW mit Transport-Anhänger**

Car with trailer

Voiture avec remorque

1:55

226x75x54 mm /8.9x3.0x2.1"

**256500001****Dodge Charger mit/with/avec Dodge Challenger SRT Racing**

1:55

235x87x61 mm /9.3x3.4x2.4"



271500001

MAN LKW mit Motorboot

Truck with motorboat
Camion avec bateau à moteur
255x97x66 mm / 10x3.8x2.6"



271700000

Freightliner Cascadia

235x115x72/9.2x4.5x2.8"



293800003

Müllwagen

Refuse truck
Camion poubelle
277x105x70 mm / 11x4.1x2.7"



294000003

Traktor mit Räumschild und Streuer

Tractor with ploughing plate and salt spreader
Tracteur avec lame et épandeur de sel
255x97x88 mm / 10x3.8x3.5"



431100001
SIKU MEGA LIFTER
 1:55
 460x273x72 mm /
 18.1x10.8x2.8"



481000001
Schwerer Mobilkran
 Heavy mobile crane
 Grue mobile géante
 1:55
 460x340x115 mm /
 18.1x13.4x4.5"



491400005
Pistenbully 600
 235x97x134 mm / 9.2x3.8x5.2"



350600001
John Deere* Dumper
 277x105x84 mm/10.9x4.1x3.3"



350700002
Manitou MHT 10230 Teleskoplader
 Telehandler
 Chariot télescopique
 225x115x65 mm/8.8x6.3x2.5"



350900000
Wacker Neuson DW60 Dumper
 155x87x59 mm/6.1x3.4x2.3"



353000003
Walzenzug
 Compactor
 Compacteur
 175x87x59 mm / 6.9x3.4x2.3"



353400002
Mercedes-Benz Atego mit Kran
 with crane
 avec grue
 225x115x65 mm / 8.9x4.5x2.6"

15
Parts

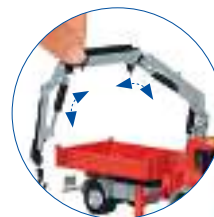

353500005
Volvo EC 290 Hydraulikbagger
 Hydraulic excavator
 Pelle hydraulique
 255x115x75 mm / 10.0x4.5x3.0"

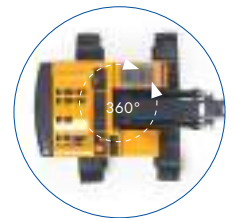

353700003

LKW mit Muldenkipper

Truck with tipping trailer

Camion à benne basculante

310x115x65 mm / 12.2x4.5x2.6"



353900003

Fahrmischer

Mixer truck

Camion toupie

235x115x65 mm

9.2x4.5x2.6"



354800001

Menzi Muck Schreitbagger

Walking excavator

Pelle araignée

216x141x91 mm / 8.5x5.5x3.5"

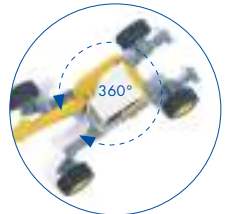

SUPER

355800002

JCB® 4CX Baggerlader
Backhoe loader
Chargeuse-pelleuse
195x97x59 mm / 7.7x3.8x2.3"



355900000

Wacker Neuson ET65 Kettenbagger
Track excavator
Pelleuse sur chenilles
155x87x51 mm / 6.1x3.4x2.0"



356000000

Wacker Neuson EW65 Mobilbagger
Mobile excavator
Pelleuse sur pneus
155x87x51 mm / 6.1x3.4x2.0"



356100001

Liebherr L 556 Radlader
Wheel-loader
Chargeuse sur pneus
210x115x72 mm / 8.3x4.5x2.8"



SUPER

356200001

Fertighaus-Transporter
Prefab house transporter
Transporteur pour maisons préfabriquées
226x141x80 mm / 8.9x5.6x3.1"

16
Parts



+ 30
Sticker

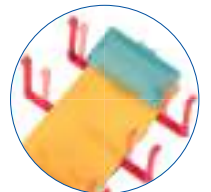
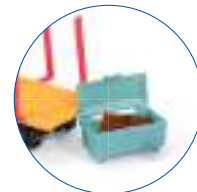

356300000

Kramer 411 Radlader
Wheel loader
Chargeuse sur pneus
139x87x51 mm / 5.4x3.4x2.0"



411700000

Mercedes-Benz 710 mit Kramer 411 Radlader Bölling
 with Kramer 411 wheel loader Bölling
 avec chargeuse sur pneus Kramer 411 Bölling
 340x97x65 mm / 13.4x3.8x2.6"



373100002

US-Schulbus
 US School bus
 Bus scolaire américain
 1:55
 235x87x61 mm / 9.3x3.4x2.4"



373400004

MAN Lion's City Stadtbüs
 City bus
 Bus urbain
 290x97x65 mm / 11.4x3.8x2.6"



373800000

Mercedes-Benz Travego Reisebus
 Coach
 Bus de tourisme
 320x105x65 mm / 12.6x4.1x2.6"



392100001

LKW mit Container
 Truck with containers
 Camion avec conteneurs
 360x115x72 mm / 14.1x4.5x2.8"



**SPIEL
SPASS
SIKU**

**PLAY
FUN
SIKU**

**JEU
PLAISIR
SIKU**



17500003

Autofähre

Car ferry
Ferry
480x180x200 mm / 18.9x7x7.8"



44 cm / 17.3"



540100001

Polizeiboot

Police boat
Bateau de police
450x150x187 mm / 17.7x5.9x7.4"



32 cm / 12.6"



551200000

Anlegestelle

Pier
Embarcadère
410x276x73 mm / 16.1x10.9x2.9"



559200000

Zubehör Wasserwege

Accessories waterways
Accessoires voies d'eau
100x75x44 mm /
3.9x2.9x1.7"



**+65
Sticker**



36 cm
14.2"

90 cm / 35.4"

Über
More than
Plus de **100**
Teile
pieces
pièces





540200001

Verkehrsflugzeug mit Zubehör
 Commercial aircraft with accessories
 Avion de ligne avec accessoires
 395x385x100 mm / 15.5x15.2x3.9"



550300000

Zugbrücke
Drawbridge
Pont-levis
305x280x93 mm / 12x11.0x3.7"



Über
More than
Plus de **40** Teile
pieces
pièces

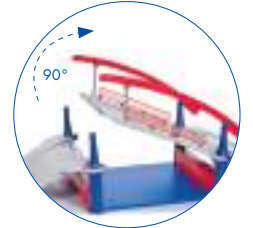

97 cm / 38.2"

550400000

Autohaus
Car showroom
Concessionnaire
276x276x45 mm / 10.9x10.9x1.8"



Über
More than
Plus de **35** Teile
pieces
pièces



35 cm
13.8"

27 cm / 10.6"

550600000

Hubschrauberlandeplatz
Heliport
Héliport
250x225x64 mm / 9.8x8.9x2.5"



leuchtet im Dunkeln nach
Luminescent
Brille dans le noir

550500004

Parkhaus
Car park
Parking
355x280x170 mm / 13.9x11x6.7"



Über
More than
Plus de **110** Teile
pieces
pièces

+37
Sticker

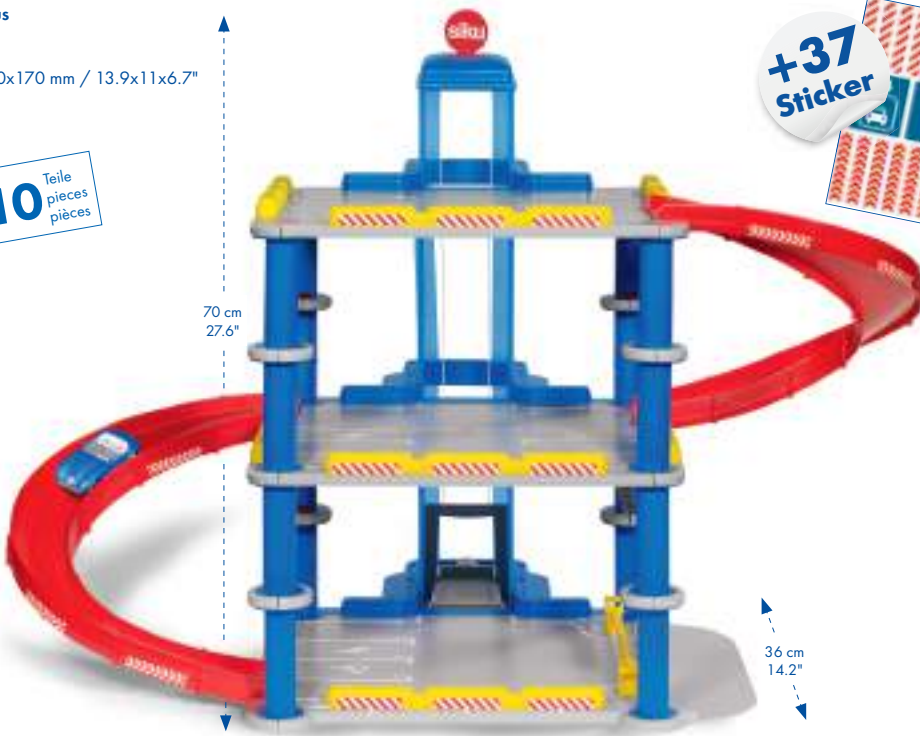

70 cm
27.6"

36 cm
14.2"



52 cm / 20.5"



179300000

Löschflugzeug

Fire fighting airplane

Avion de lutte anti-incendie

313x233x125 mm / 12.3x9.2x4.9"

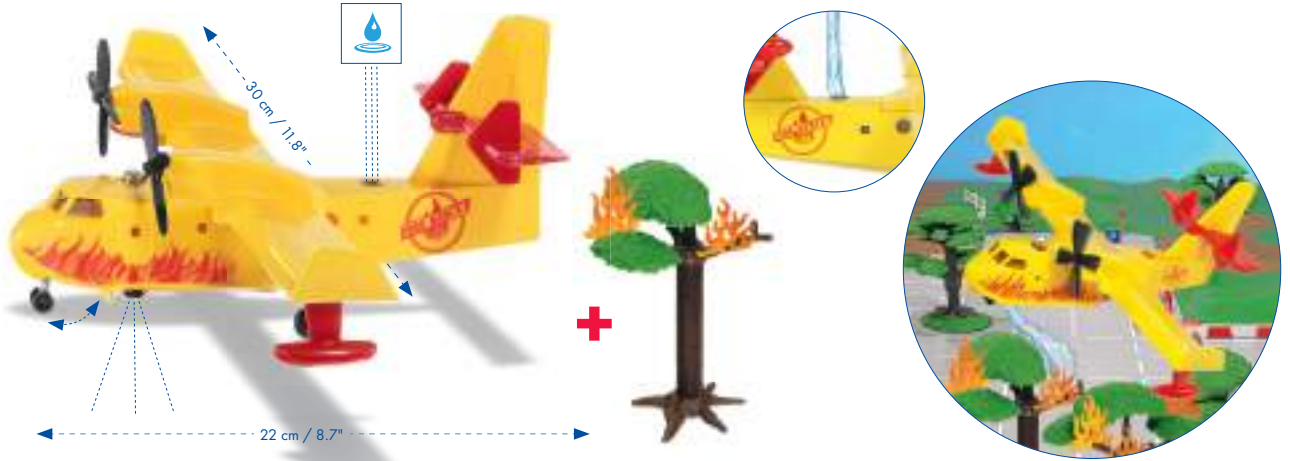

550700001

Werkstatt

Garage

Atelier mécanique

276x276x45 mm / 10.9x10.9x1.8"



WORLD

Über
More than
Plus de **40**
Teile
pieces
pièces



559400000

Schilder und Leuchten

Road signs and street lamps

Panneaux et réverbères

185x115x45 mm / 7.2x4.5x1.8"

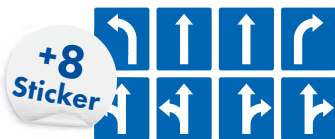

559700004

Ampeln mit Verkehrsschildern

Traffic lights and road signs

Panneaux et feux de signalisation

100x75x44 mm / 3.9x2.9x1.7"



550800001
Feuerwache
 Fire station
 Caserne de pompiers
 410x276x103 mm/16.1x10.9x4"



Über **90** Teile
 More than **90** pieces
 Plus de **90** pièces

+ 41
 Sticker



29 cm
11.4"

29 cm
11.4"

78 cm / 30.7"

551000000
Polizeistation
 Police station
 Station de police
 410x276x73 mm/10.9x10.9x3.1"



Über **90** Teile
 More than **90** pieces
 Plus de **90** pièces

+ 37
 Sticker





560800000
Bauernhof
Farm
Ferme
410x276x73 mm / 10.9x10.9x3.1"

Über **90** Teile
More than Plus de **90** pieces
pièces pièces

+29
Sticker



Schiebetür
Sliding door
Porte coulissante



Falltür
Trapdoor
Trappe



Seilzug
Cable pull
Palan



560200000
Stand silo
Vertical silo
Silo
276x276x60 mm / 10.9x10.9x2.4"



569900000
Feldwege und Wald
Dirt tracks and forest
Chemins de campagne et forêt
276x276x80 mm / 10.9x10.9x3.1"



+1
Sticker

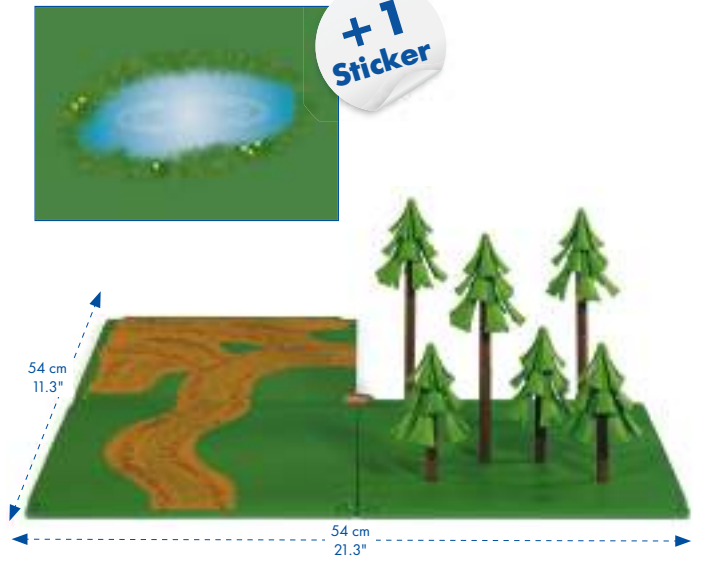

560600003
Fahrsilo mit Plane, Reifen und Granulat
Silage clamp with cover, tyres and granulate
Silo horizontal avec bâche, pneus et granulés
276x276x45 mm / 10.9x10.9x1.7"



ALLES UNTER KONTROLLE MIT SIKUCONTROL

EVERYTHING UNDER CONTROL
WITH SIKUCONTROL

TOUT EST SOUS CONTRÔLE
AVEC SIKUCONTROL

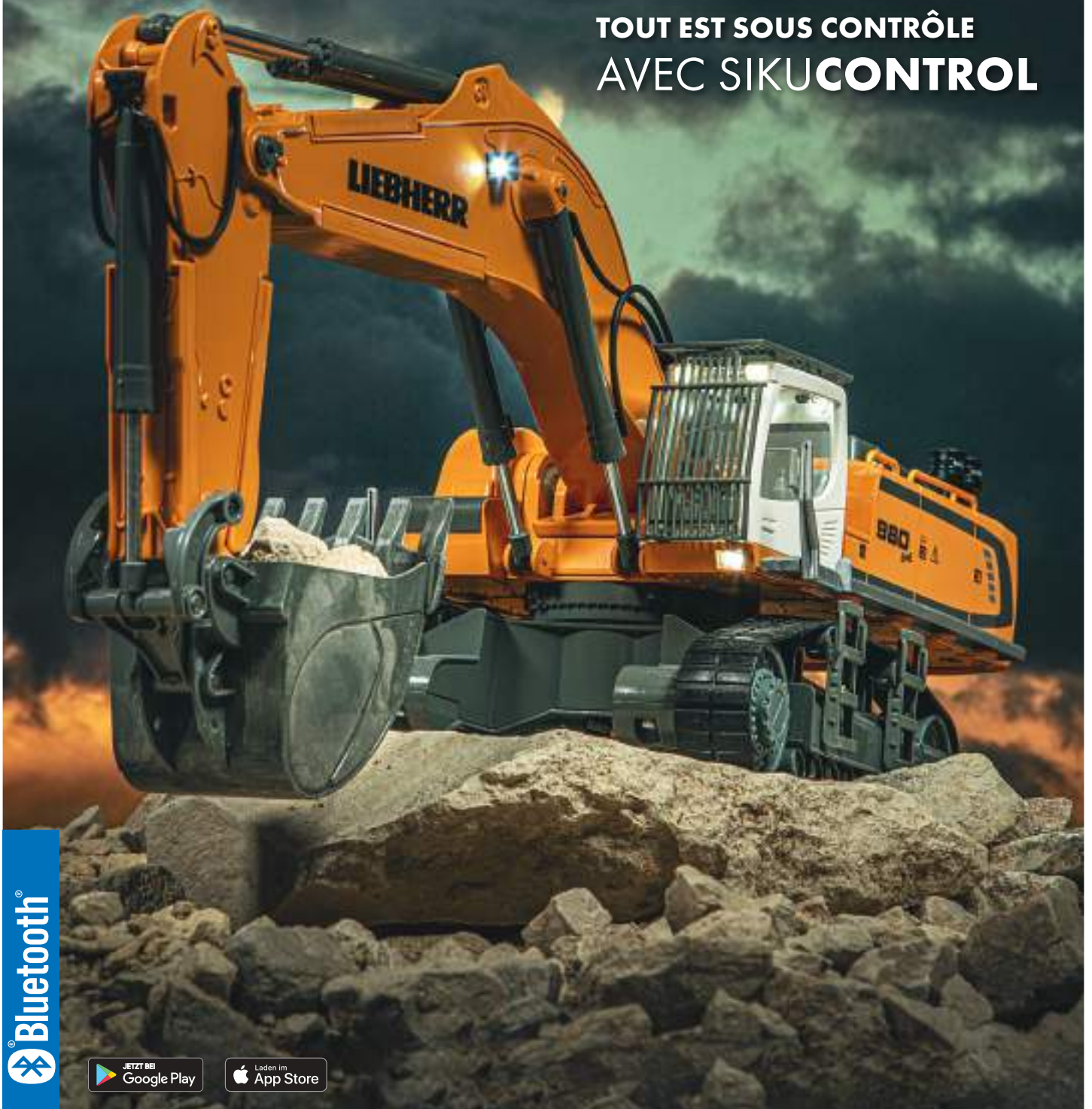

Bluetooth®

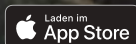

673100000

Volvo FH16 mit Bluetooth App-Steuerung
with Bluetooth app control
à commande par application Bluetooth
265x175x147 mm / 10.4x6.8x5.7"

673700000
Set 6731 + 6730

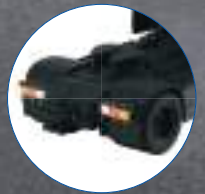
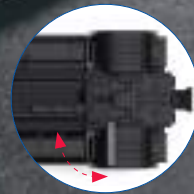

Bluetooth

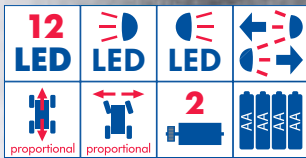

673400000

3-Achs-Kippsattelaufleger
3-axle-tipping semi trailer
Semi-remorque à benne basculante 3 essieux
295x175x147 mm / 11.6x6.8x5.7"

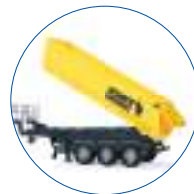

671700000

Bluetooth Fernsteuermodul für Raupenbagger (6741)
Bluetooth remote control for crawler excavator
Télécommande Bluetooth pour excavateur sur chenilles
147x175x80 mm / 5.8x6.9x3.1"

Bluetooth



674400000

3-Achs-Tieflader
3-axle-low loader
Remorque surbaissé à 3 essieux
450x125x89 mm / 17.7x4.9x3.5"

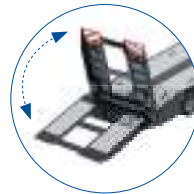

673000000

Bluetooth Fernsteuermodul
Bluetooth remote control
Télécommande Bluetooth
147x175x80 mm / 5.8x6.9x3.1"

Bluetooth



Einsetzbar für
Suitable for
Convenable pour
6731, 6735, 6736,
6737, 6738, 6739,
6788, 6789,
6790, 6791, 6792,
6793, 6794, 6795,
6796, 6797, 6798,
6799, 6885

CONTROL

671400000

Zubehörset für SIKUCONTROL Tieflader und Zugmaschine
 Accessories set for SIKUCONTROL low loader and truck
 Set d'accessoires pour surbaissé et camion SIKUCONTROL
 308x158x68 mm / 12.1x6.2x2.7"

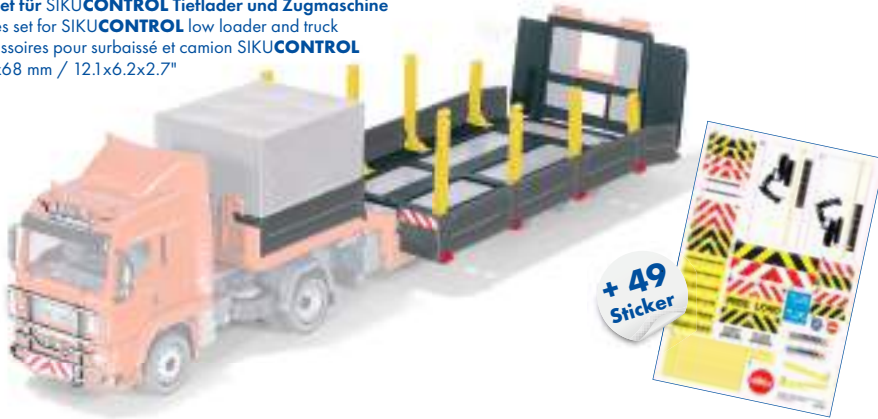

+ 49
Sticker



674100000

LIEBHERR R980 SME Raupenbagger mit Bluetooth App-Steuerung
 Crawler excavator with Bluetooth app control
 Excavateur sur chenilles avec commande par application Bluetooth
 439x220x205 mm / 17,3x8,7x8,1"

6740000002

Set 6741 + 6717
 439x220x205 mm/
 17,3x8,7x8,1"

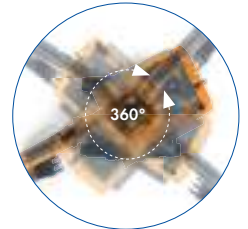

CONTROL

 Bluetooth

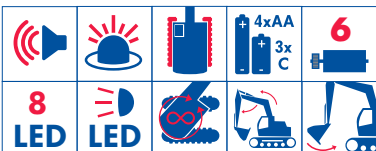

* Der Sound ist nur mit der App abspielbar
 * Sound is only available in the app
 * Le son n'est possible qu'avec l'application



673500000

John Deere* 7290R mit Doppelreifen und Bluetooth App-Steuerung
 on duals and with Bluetooth app control
 à roues jumelées avec commande par application Bluetooth
 295x175x147 mm / 11.6x6.8x5.7"

673600000

Set 6735 + 6730
 378x178x150/14.8x7x5.9"

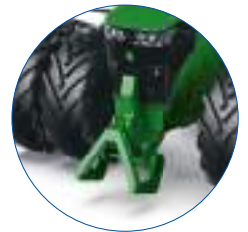

14 LED	LED	LED	LED	LED	3
proportional	proportional	proportional	SIKUFARMER	SIKUFARMER	AAA AAA AAA



673800000

New Holland T7.315 mit Doppelreifen und Bluetooth App-Steuerung
 on duals and with Bluetooth app control
 à roues jumelées avec commande par application Bluetooth
 295x175x147 mm / 11.6x6.8x5.7"

673900000

Set 6738 + 6730
 378x178x150/14.8x7x5.9"

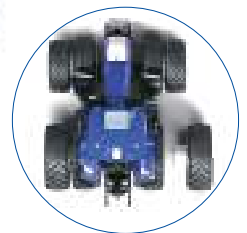

12 LED	LED	LED	LED	LED	3
proportional	proportional	proportional	SIKUFARMER	SIKUFARMER	AAA AAA AAA



Bluetooth

CONTROL

678800000

Claas Xerion 5000 Trac VC Jubiläumsmodell 25 Jahre Claas Xerion
 mit Bluetooth App-Steuerung
 Anniversary model with Bluetooth app control
 Modèle anniversaire avec commande par application Bluetooth
 295x175x147 mm / 11.6x6.9x5.8"



Bluetooth

22 LED	LED	LED					



679000000

Fendt 1167 Vario MT mit Bluetooth App-Steuerung
 with Bluetooth app control
 avec commande par application Bluetooth
 295x175x147 mm / 11.6x6.9x5.8"



678900000

Set 6790 + 6730
 378x178x150 mm / 14.9x7.0x5.9"



Bluetooth

* Der Sound ist nur mit der App abspielbar
 * Sound is only available in the app
 * Le son n'est possible qu'avec l'application

14 LED	LED	LED				



CONTROL

679100000

Claas Xerion 5000 Trac VC mit Bluetooth App-Steuerung
with Bluetooth app control
avec commande par application Bluetooth
295x175x147 mm / 11.6x6.9x5.8"



679400000

Set 6791 + 6730
378x178x150 mm / 14.9x7.0x5.9"



Abbildung zeigt auch Produkt 6715
Picture also shows product 6715
Image montre aussi le produit 6715

CONTROL

671300000

Adapter für Frontladeranbaugeräte
Adapter for front loader accessories
Adaptateur accessoires pour chargeur frontal

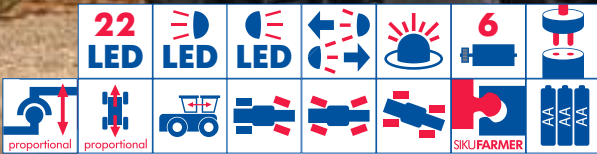

Für · for · pour
6777, 6778, 6792, 6793, 6795, 6796, 6797, 6798

288700002

Dolly SIGA Duo
210x87x88 mm / 8.3x3.4x3.5"



671500000

Zusatzräder für Claas Xerion 5000 Trac VC (6788/6791/6794)
Additional wheels
Roues additionnelles
147x175x55 mm / 5.7x6.9x2.1"



Batterieübersicht

Usages of the batteries
L'emploi des piles et batteries

	Batterie-Typ Battery type Type de pile	Batterie-Typ Battery type Type de pile	Batterie-Typ Battery type Type de pile
zu verwenden mit / use with / à employer avec	AAA	AA	C
6717, 6740		•	•
6741			•
6735, 6738, 6778, 6792, 6793, 6797, 6880, 6881, 6882	•		
6736, 6739, 6777, 6795, 6796, 6798	•	•	
6717, 6730, 6731, 6737, 6788, 6789, 6790, 6791, 6794, 6799, 6885		•	



679200000

John Deere* 7310R mit Frontlader und Bluetooth App-Steuerung
with front loader and Bluetooth app control
avec chargeur frontal et commande par application Bluetooth
295x175x147 mm / 11.6x6.9x5.8"

679500000

Set 6792 + 6730 
378x178x150 mm / 14.9x7.0x5.9"









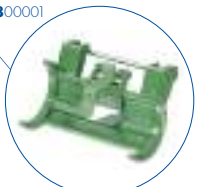









Art. Nr. 366100000



Art. Nr. 365800001



Bluetooth®

 14 LED	 LED	 LED	 LED	 LED	 5		
 proportional	 proportional	 proportional	 proportional	 proportional	 snap-in-place	 proportional	 SIKUFARMER



*John Deere Produkte sind nicht in allen Ländern erhältlich. · John Deere products are not available in all countries. · Les produits John Deere ne sont pas disponibles dans tous les pays.

679300000

Fendt 933 Vario mit Frontlader und Bluetooth App-Steuerung
with front loader and Bluetooth app control
avec chargeur frontal et commande par application Bluetooth
295x175x147 mm / 11.6x6.9x5.8"

679600000

Set 6793 + 6730
378x178x150 mm / 14.9x7.0x5.9"



Art. Nr. 366100000



Art. Nr. 365800001

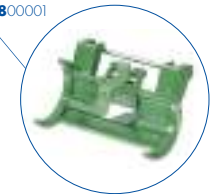

10 LED	LED	LED	LED	LED	5	AAA AAA AAA
proportional	proportional	proportional	proportional	proportional	snap-in-place	proportional



679700000

New Holland T7.315 mit Frontlader und Bluetooth App-Steuerung
with front loader and Bluetooth app control
avec chargeur frontal et commande par application Bluetooth
295x175x147 mm / 11.6x6.9x5.8"

679800000

Set 6797 + 6730
378x178x150 mm / 14.9x7.0x5.9"



Art. Nr. 366100000



Art. Nr. 365800001

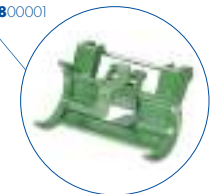

12 LED	LED	LED	LED	LED	5	AAA AAA AAA
proportional	proportional	proportional	proportional	proportional	snap-in-place	proportional



Bluetooth

Bluetooth

CONTROL

67800002

Tandem-Achs-Anhänger
Tandem trailer (twin axled)
Remorque tandem 2 essieux
305x180x107 mm / 12.0x7.1x4.2"

**67810002**

Zweiseitenkipper
Two-way tipping trailer
Remorque basculante bilatérale
305x180x95 mm / 12.0x7.1x3.7"

**67820001**

2-Kreisel-Schwader
Twin rotor rake
Andaineuse rotative à disques
305x220x124 mm / 12.0x8.7x4.8"

**67860000**

3-Achs-Hakenliffahrgestell mit Mulde
3-axled hooklift trailer
Benne 3 essieux sur crémaillère déposable
355x180x107 mm / 14.0x7.1x4.2"



68800004

Fendt 939 Set mit Fernsteuerung
with remote control
avec télécommande
355x205x124 mm / 14x8.0x4.8"



688100004

John Deere* 8345R Set mit Fernsteuerung
with remote control
avec télécommande
355x205x124 mm / 14x8.0x4.8"



688200004

Claas Axion 850 Set mit Fernsteuerung
with remote control
avec télécommande
355x205x124 mm / 14x8.0x4.8"



SYMBOLE · SYMBOLS · SYMBOLES

- 10 LED** Anzahl der LEDs
Number of LEDs
Nombre de LEDs
- LED** Fahrlicht
Headlights
Feux de route
- LED** Rücklicht
Rear light
Feu arrière
- Blinker und Warnblinker**
Indicator and hazard warning lights
Clignotants et signal feux de détresse
- Rundumleuchten**
Flashing beacon
Gyrophares
- 6** Anzahl der Getriebe
Number of gear boxes
Nombre de moteurs de transmission
- Stufenlose Lenkung**
Adjustable steering
Direction proportionnelle
- Stufenlose Fahrfunktion**
Adjustable driving performance
Marche proportionnelle
- Stützfüße**
Landing gears
Pieds de soutien
- Kippbare Mulde**
Tipping trailer
Benne basculante
- 360° drehbar**
Rotatable through 360°
Rotation à 360°
- Beweglicher Baggerarm**
Movable digger arm
Braz d'excavateur mobile
- Bewegliche Schaufel**
Movable shovel
Pelle mobile
- Raupenfahrwerk**
Crawler track
Châssis sur chenilles
- Parallelführung**
Parallel motion
Guidage parallèle
- Frontlader**
Front loader
Chargeur frontal
- Heb- und senkbarer Frontlader**
Lifting/lowering front loader
Chargeur frontal levable et abaissable
- Abnehmbare Schaufel**
Detachable shovel
Pelle démontable
- Datenschnittstelle für Zusatzgeräte**
Data interface for additional equipment
Connexion interface pour accessoires
- Kompatibel zu SIKUFARMER 1:32-Modellen**
Compatible with all SIKUFARMER 1:32 products
Compatible avec les modèles SIKUFARMER au 1/32ème
- Batterie**
Battery
Piles
- Drehbare Kabine**
Rotatable cab
Cabine pivotante
- Standardlenkung**
Standard steering
Mode standard de direction
- Allradlenkung**
All-wheel steering
Quatre roues directrices
- Hundegang**
Crab steering
Marche crabe
- Ton**
Sound
Son
- Zum Ankuppeln**
For coupling
Pour attelage

**LANDWIRTSCHAFT,
WO ABENTEUER
WACHSEN.**

**AGRICULTURE –
LET ADVENTURES GROW**

**L'AGRICULTURE
OÙ POUSSENT LES AVENTURES.**



179400000

John Deere* 8500i
139x75x68 mm / 5.5x3.0x2.7"

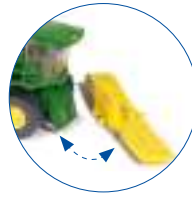

179900000

New Holland mit Kverneland Pflanzenschutzspritze
with crop sprayer
avec pulvérisateur
195x75x44 mm / 7.7x3.0x1.7"

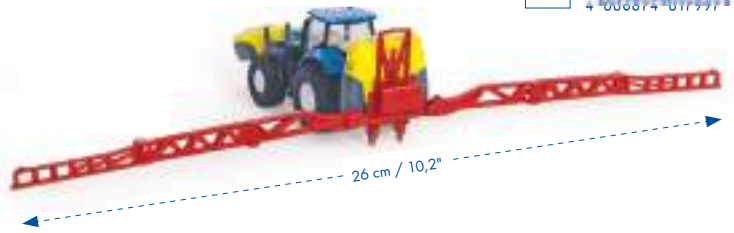

180500001

LKW mit New Holland Traktoren
Truck with New Holland tractors
Camion avec tracteurs New Holland
260x75x48 mm / 10.2x3.0x1.8"



182600002

Traktor mit Sämaschine
Tractor with seeder
Tracteur avec semoir
210x75x54 mm / 8.3x3.0x2.1"



182700002

Claas Xerion mit Fasswagen
with vacuum tanker
avec remorque épandeur
226x75x54 mm / 8.9x3.0x2.1"



183700001

Tieflader mit John Deere* Traktoren
Low loader with John Deere* tractors
Camion surbaissé avec tracteurs John Deere*
260x75x48 mm / 10.3x3.0x1.9"



184300002

John Deere* mit Frontlader und Anhänger
with front loader and trailer
avec chargeur frontal et remorque
226x75x54 mm / 8.9x3.0x2.1"

**184400001**

Massey Ferguson mit Anhänger
with trailer
avec remorque
226x75x54 mm / 8.9x3.0x2.1"

**184800001**

DEUTZ-FAHR mit Joskin Anhängerset
with Joskin trailer set
avec kit de remorques Joskin
280x131x51 mm / 11x5.2x22"

**185600001**

John Deere* 9630 mit Amazone Centaur
with Amazone Centaur
avec Amazone Centaur
226x75x80 mm / 8.9x3.0x3.1"

**185800002**

JCB® mit Dolly und Kippmulde
with dolly and tipping trailer
avec dolly et benne basculante
226x75x54 mm / 8.9x3.0x2.1"

**187600002**

John Deere* T670i Mähdrescher
Combine harvester
Moissonneuse-batteuse
156x75x115 mm / 6.1x3.0x4.5"



194500001

Traktor mit Ein-Achs-Güllefass
 Tractor with single axle vacuum tanker
 Tracteur avec réservoir de lisier à 1 essieu
 277x105x70 mm / 10.9x4.1x2.7"



194700003

Traktor mit Silagewagen
 Tractor with silage trailer
 Tracteur avec remorque d'ensilage
 385x115x65 mm / 15.2x4.5x2.5"



194900002

Traktor mit Frontlader, Dolly und Muldenkipper
 Tractor with front loader, dolly and tipping trailer
 Tracteur avec chargeur frontal, dolly et benne basculante
 420x115x65 mm / 16.5x6.3x2.5"



195300003

Traktor* mit Anhänger
 Tractor* with trailer
 Tracteur* avec remorque
 320x97x65 mm / 12.6x3.8x2.6"

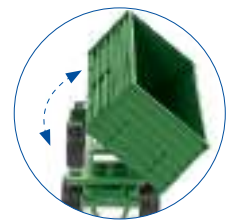

195400003

Traktor* mit Forstanhänger
 Tractor* with forestry trailer
 Tracteur* avec remorque forestière
 310x115x65 mm / 12.2x4.5x2.6"

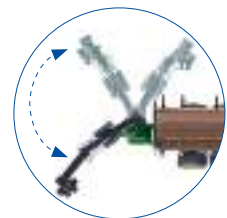
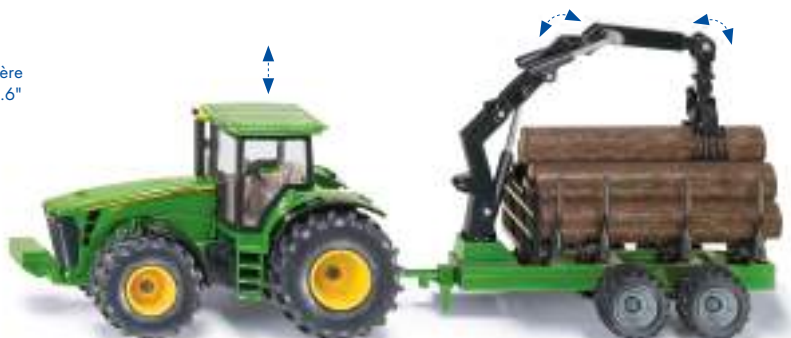

197900002

Claas Axion 850 mit Frontlader
with front loader
avec chargeur frontal
195x115x66 mm /
7.7x4.5x2.6"

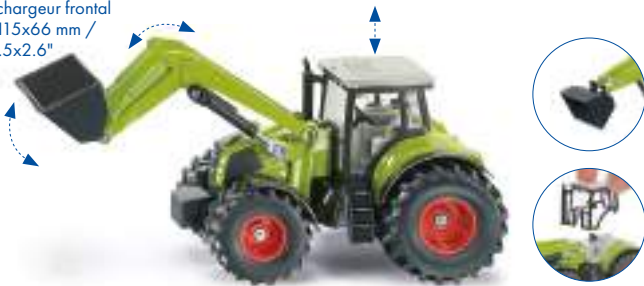

198200002

John Deere* mit Frontlader
with front loader
avec chargeur frontal
195x115x66 mm / 7.7x4.5x2.6"



198500002

Massey Ferguson mit Frontlader
with front loader
avec chargeur frontal
195x115x66 mm / 7.6x4.5x2.5"



199000000

Fendt 942 Vario mit Frontlader
with front loader
avec chargeur frontal
195x115x66 mm / 7.7x4.5x2.6"



198900001

Fendt mit Hakenliffahrgestell und Mulde
 Fendt with hooklift trailer and carriage
 Fendt avec benne sur crémaillère déposable
 340x97x65 mm / 13.4x3.8x2.6"



199100004

Claas Mähdrescher
 Combine harvester
 Moissonneuse-batteuse
 280x141x205 mm / 11x5.6x8"



199300004

Claas Maishäcksler
 Forage harvester
 Ensileuse à maïs
 255x115x106 mm / 10x4.5x4.2"



199900002

Claas Torion 1914 Radlader
 Wheel loader
 Chargeuse sur pneus
 210x115x72 mm / 8.2x4.5x2.8"

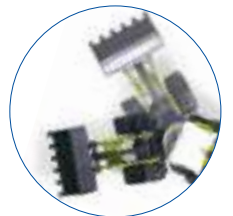

200000001

Fendt 942 Vario mit Frontmäherwerk
 with front mower
 avec faucheuse avant
 195x97x71 mm / 7.7x3.8x2.8"



206700000**Pöttinger Grubber Synkro**Cultivator
Cultivateur
175x97x110 mm / 6.9x3.8x4.3"**245000001****Strautmann Futtermischwagen**Fodder mixer
Malaxeur de fourrage
226x131x78 mm / 8.9x5.2x3.1"**206900000****Amazone Centaur**

320x151x166mm / 9x4.5x6.5"

**227000001****Fasswagen**Vacuum tanker
Remorque épandage d'engrais
385x151x98 mm / 15.2x6.0x3.9"**245100001****Schwader**Whirl rake
Andaineuse
250x181x51 mm / 9.8x7.1x2.0"**245600001****Kuhn Heckmähwerk**Rear disc mower
Faucheuse-conditionneuse trainée
170x75x54 mm / 6.7x3.0x2.1"**246100001****Kuhn Frontmähwerk**Front disc mower
Faucheuse à disque frontale
155x75x65 mm / 6.1x3.0x2.6"

246300001

Ballensortiment

Bale assortiment
Set balles de foin
360x115x51 mm / 14.1x4.5x2.0"



246400001

10 Abspergitter

10 Barrières
10 Barrières
155x87x51 mm / 6.1x3.4x2.0"



246500001

John Deere* Ballenpresse

Round baler
Presse à ballots
210x131x103 mm / 8.2x5.1x4.0"



246600001

Elektrisches Förderband

Electric conveyor
Convoyeur à courroie électrique
380x151x115 mm / 15.0x6.01x4.5"

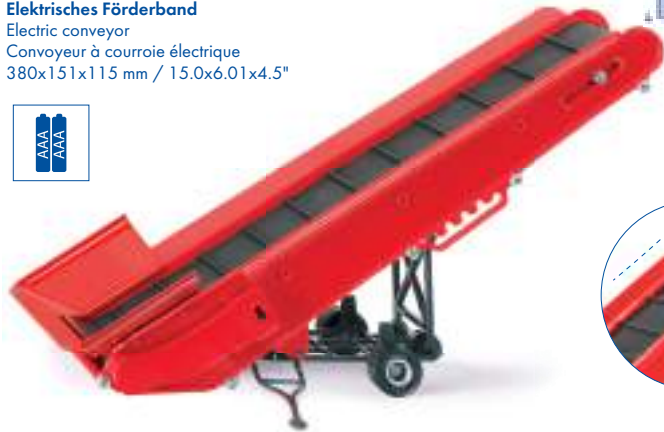

246800000

Holzspalter

Wood splitter
Fendeuse à bois
115x115x60 mm
/4.5x4.5x2.3"



246700001

Maisschiebeschild

Maize leveller
Lame niveleuse pour maïs
175x97x88 mm / 6.8x3.8x3.4"



287300001

Silagewagen

Silage trailer
Remorque d'ensilage
316x161x94 mm / 12.4x6.3x3.7"



287500002

Viehanhänger

Livestock trailer
Remorque à bétail
290x131x96 mm
11.4x5.2x3.8"



288700002

Dolly SIGA Duo

210x87x88 mm / 8.3x3.4x3.5"

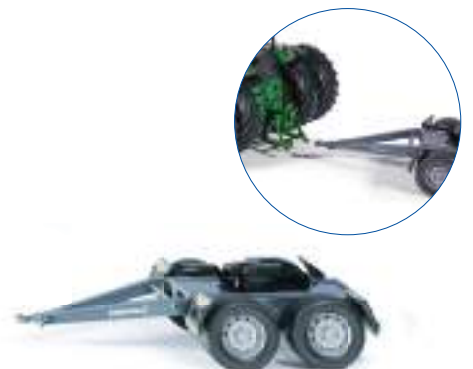

289100001**Rundballenanhänger**

Trailer for round bales

Remorque à balles rondes

290x131x96 mm / 11.4x5.2x3.8"

**289200001****Joskin Dreiachs-Muldenkipper**

Triple-axle tipping trailer

Benne mono-coque 3 essieux

340x161x95 mm / 13.4x6.3x3.7"

**289800000****Zwei-Achs-Anhänger**

4-wheel-trailer

Remorque 2 essieux

210x115x82 mm / 8.3x4.5x3.2"

**304900001****Manitou 3300V Kompaktlader**

Skid steer loader

Mini chargeur

195x97x71 mm / 7.7x3.8x2.8"



Passendes Frontladerzubehör auf Seite 91
Matching front loader accessories on page 91
Accessoires convenables de chargeur frontal à la page 91

305900006**Weidemann Hoftrac**

175x115x54 mm / 6.9x4.5x2.1"

**306800001****Aebi TerraTrac TT211**

235x97x78 mm / 9.2x3.8x3"

**306100000****Lindner Unitrac mit Ladewagen**

with loader wagon

avec wagon de chargement

255x115x91 mm / 9.8x5.4x3.6"



306700001

Manitou MLT840 Teleskoplader
Telehandler
Chariot télescopique
255x131x98 mm / 10x5.2x3.9"

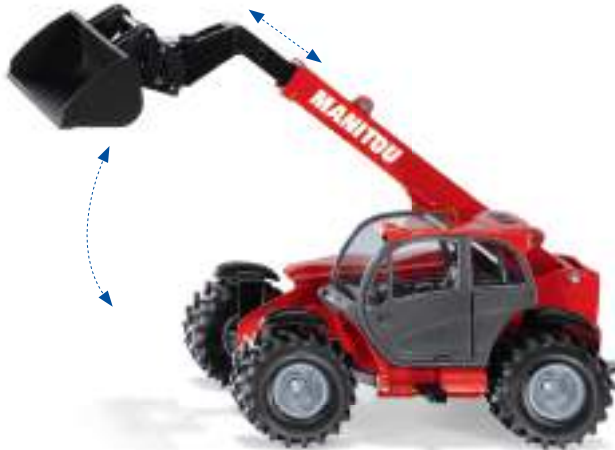

Passendes Frontladerzubehör auf Seite 91
Matching front loader accessories on page 91
Accessoires convenables de chargeur frontal à la page 91

327500002

Case IH Quadtrac 600
316x171x110 mm / 12.4x6.7x4.3"



327100001

Claas Xerion
316x171x125 mm / 12.4x6.7x4.9"



328500001

Fendt 724 Vario
226x141x102 mm / 8.9x5.6x4.0"



328000001

Claas Axion 950
250x151x102 mm / 9.8x5.9x4.0"



328200001

John Deere* 6210R
250x151x102 mm / 9.8x5.9x4.0"



FARMER



328700001
Fendt 1050 Vario
 250x151x110 mm / 9.8x6x4.3"



329000000
John Deere* 8R 370
 250x151x110 mm / 9.8x5.9x4.3"



329100000
New Holland T7.315 HD
 250x151x110 mm / 9.8x5.9x4.3"



329200000
John Deere* 8R 410
 mit Doppelbereifung
 on duals
 à roues jumelées
 250x151x165 mm / 9.8x5.9x6.5"



FARMER

*John Deere Produkte sind nicht in allen Ländern erhältlich. · John Deere products are not available in all countries. · Les produits John Deere ne sont pas disponibles dans tous les pays.

329300000

Fendt 728 Vario

250x151x102 mm / 9.8x6x4"



365200001

John Deere* mit Frontlader

with front loader

avec chargeur frontal

255x131x84 mm / 10.0x5.2x3.3"



Passendes Frontladerzubehör auf Seite 91
Matching front loader accessories on page 91
Accessoires convenables de chargeur frontal à la page 91

366300002

JCB® 435S Agri Radlader

Agri wheel loader

Agri-chargeuse sur pneus

300x151x145 mm / 11.8x 6x5.7"



Passendes Frontladerzubehör auf Seite 91
Matching front loader accessories on page 91
Accessoires convenables de chargeur frontal à la page 91

406600001

Krone BiG X 580 Maishäcksler

Forage harvester

Enseleuse à maïs

360x181x200 mm / 14.1x7.1x7.8"





Abbildung zeigt Sonderedition
Picture shows special edition
Image montre une édition spéciale

487000001

Jeep Wrangler

155x87x80 mm / 6.1x3.4x3.1"



ZUBEHÖR | ACCESSORIES | ACCESSOIRES

309500001

Adapter-Set mit Frontgewicht

Adaptor set and front weight

Set poids avant et adaptateur

1:32

139x75x44 mm / 5.4x3x1.7"



366100000

Frontlader Anbaugeräte

Front loader accessories

Accessoires pour chargeur frontal

1:32

210x131x59 mm /

8.3x5.2x2.3"



701500000

50 Paletten

50 Pallets

50 Palettes

1:50

180x32x120 mm / 7x1.2x4.7"



für Art.-Nr.
for item
pour réf.
1722, 3507



365800001

Frontlader Zubehör

Front loader accessories

Set accessoires

pour chargeur frontal

1:32

290x131x54 mm /

11.4x5.2x2.1"





152500100
Chevrolet Corvette ZR1
 Polizei Frankreich
 Police France



163600103
Unimog Feuerwehr mit Boot
 Fire engine with boat
 Pompiers avec bateau



101400101
Feuerwehdrehleiter Frankreich
 Fire engine France
 Échelle de pompiers France



181800100
Feuerwehr-Set Frankreich
 Fire brigade set France
 Set pompiers France
 210x100 mm / 8.2x3.9"





FRANCE*

SIKUIINTERNATIONAL

siku

181900100
Notruf-Set Frankreich
Emergency set France
Set de véhicules de secours France
210x100 mm / 8.2x3.9"



103600102
Tanklöschfahrzeug
Fire Engine
Camion pompiers



080600101
Polizei Transporter
Police Van
Fourgon de police



145000101
BMW M3 Coupé
Polizei Frankreich
Police française
French Police



161700103
RATP Gelenkbus
Articulated bus
Bus à soufflet



164600103
RATP Nahverkehrszug
Local train
Train de banlieue
1:120



179100101
RATP Doppelstock-Zug
Double-deck train
Train à deux étages
1:87
250x75x42 mm / 9.8x2.9x1.6"



373400102
RATP Stadtbüs
City bus
Bus urbain
1:50
290x97x65 mm /
11.4x3.8x2.6"



373800101
RATP Mercedes-Benz Travego
Reisebus
Coach
Bus de tourisme
1:50
320x105x65 mm /
12.6x4.1x2.6"



*Die hier gezeigten Modelle können Sie ab Lüdenscheid bei siku bestellen · You can order the models shown above from siku Germany · Les modèles ci-dessus peuvent être commandés chez siku en Allemagne



<p>080503802 Rettungsdienst Ambulance</p>  	<p>146003800 Feuerwehr Einsatzleitung Fire command car Voiture de pompiers</p>  	<p>253903802 ÖAMTC-Hubschrauber Helicopter Hélicoptère 1:55 235x97x59 / 9.3x3.8x2.3"</p>   
<p>271203804 ÖAMTC-Abschleppwagen Breakdown truck Dépanneuse 1:55 210x87x54 mm 8.3x3.4x2.1"</p>   		



<p>080500302 Krankenwagen Niederlande Dutch Ambulance Ambulance Pays-Bas</p>  	<p>080600300 Polizeibus Police van Fourgon de police</p>  	<p>080800300 Feuerwehr Transporter Command Car Comionnette pompiers</p>  
<p>101400300 Feuerwehrdrehleiter Niederlande Dutch Fire Truck Échelle de pompiers Pays-Bas</p>  	<p>103600300 Tanklöschfahrzeug Niederlande Dutch Fire engine Camion de pompiers Pays-Bas</p>  	<p>145000301 BMW M3 Coupé Polizei Niederlande Dutch Police Police Pay-Bas</p>  
<p>181800300 Feuerwehr-Set Niederlande Dutch Fire brigade set Set pompiers Pays-Bas 210x100 mm / 8.2x3.9"</p>  	<p>181900300 Notruf-Set Niederlande Dutch Emergency set Set de véhicules de secours Pays-Bas 210x100 mm / 8.2x3.9"</p>  	

INTERNATIONAL



2211503901

Mercedes-Benz Sprinter Miesen Typ C Ambulanz

Type C Ambulance

Ambulance de type C

175x87x59 mm / 6.9x3.4x2.3"



182403906

"Swiss 1"

Notruf-Set

Rescue-Set

Véhicules de secours

208x96 mm / 8.1x3.7"



2199703901

MAN LKW mit Kofferaufbau, Ladebordwand und Gitterbox

MAN Truck with box body and tail lift

Camion MAN porte-caisse avec hayon élévateur

1:50

277x105x70mm/10.9x4.1x2.7"



037403903

MAN Postbus

Bus postal

1:50

290x97x65 mm / 11.4x3.8x2.6"



2373803901

Postauto

Car Postal

Auto Postale

1:50

320x105x65mm/12.6x4.1x2.6"





080600600
Police Van

143700601
Firefighter Car

145000601
Police Car

164600701
Local train
1:120

621300707
Bugatti set 8
170x57x100 mm / 6.7x2.2x3.9"

Limited Edition

629100701
Bentley set 1
170x57x100 mm / 6.7x2.2x3.9"

Limited Edition

621400702
Mercedes set 2
170x57x100 mm / 6.7x2.2x3.9"

Limited Edition

628300002
Gift set construction

628600002
Gift set agriculture

163200701
John Deere 7530 with bale trailer

N

164200701
New Holland tractor with
Abbey tanker

N

163000701
Tractor with universal
spreader

N

INTERNATIONAL

*Bei Interesse wenden Sie sich bitte an unseren Importeur im jeweiligen Land · If you are interested, please contact our importer in the respective country · Si vous êtes intéressé, s'il vous plaît contacter notre importateur dans le pays respectif

N Neu: Liefertermin folgt
New: release date follows
Nouveau: date de livraison à venir



GREAT BRITAIN*



IRELAND*

SIKUIINTERNATIONAL



245000701
Abbey Fodder mixer
1:32
226x131x78
8.9x5.2x3.1"



226600704
Bale wrapper
1:32
210x115x72
8.3x4.3x3.0"



227000701
Abbey Tanker
385x151x98 mm / 15.2x6.0x3.9"
1:32



325299900
John Deere 6920S*
1:32
216x131x82/
8.5x5.2x3.2"



383899901
**John Deere 6175R
with round baler**
1:32
420x160x98 mm /
16.5x6.2x3.9"



226500001
Claas Large-scale mower
1:32
255x115x42 mm
10x4.5x1.7"



246900701
Kuhn Hedge cutter
1:32
210x115x88 mm
8.3x4.5x3.5"



226800001
Claas Round baler
1:32
225x115x65 mm
8.9x4.5x2.5"



860800001
**Massey Ferguson MF 8680 with Ifor-Williams stock trailer
muddy version**
1:32
500x160x95/19.6x6.2x3.7"



366300701
**JCB® 4365
Agri wheel loader**
1:32
210x115x72/8.3x4.3x3.0"



Limited Edition

*Bei Interesse wenden Sie sich bitte an unseren Importeur im jeweiligen Land · If you are interested, please contact our importer in the respective country · Si vous êtes intéressé, s'il vous plaît contacter notre importateur dans le pays respectif



<p>182400900 Police Set 210x100 mm 8.2x3.9"</p>  	<p>181800900 Fire Brigade Set 210x100 mm 8.2x3.9"</p>  	<p>182500901 Ambulance Set 210x100 mm 8.2x3.9"</p>  	<p>181900901 Emergency Set 210x100 mm 8.2x3.9"</p>  
<p>080600900 Police Van</p>   	<p>080800900 Command Car</p>   	<p>080900900 Ambulance</p>   	
<p>104900900 Police Motorbike</p>   	<p>103600900 Fire Engine</p>  	<p>108300900 Emergency service</p>   	
<p>141000902 Patrol Car</p>   	<p>143700901 Firefighter Car</p>   	<p>141100901 Ambulance Car</p>   	
<p>145000901 Greek Police BMW M3 Coupé</p>  	<p>146900900 Greek Police VW Amarok</p>    	<p>152500900 Greek Police Chevrolet Corvette ZR1</p>   	
<p>230600901 Mercedes-AMG G65 Fire Brigade 1:50 155x75x65 mm / 6.9x3.4x2.3"</p>    	<p>230800901 Mercedes-AMG G65 Federal Police 1:50 155x75x65 mm / 6.9x3.4x2.3"</p>    	<p>234500901 Mercedes-AMG G65 Emergency Car 1:50 155x75x65 mm / 6.9x3.4x2.3"</p>    	

INTERNATIONAL



540100901

Police boat
450x150x187 mm /
17.7x5.9x7.4"



161700901
Articulated Bus



162600903
Articulated tank truck





<p>080606400 Police Van</p>  	<p>104906400 Police Motorbike</p>  	<p>140206401 Patrol Car</p>  
<p>101406400 Firefighter Car</p>  	<p>103606400 Fire Engine</p>  	



<p>138803000 Schwedische Feuerwehr Swedish fire engine Pompieris suédois</p>  	<p>138903001 Schwedische Ambulanz Swedish Ambulance Ambulance suédois</p>  	<p>145003001 Schwedische Polizei Swedish police car Police suédois</p>  
---	--	---



182503000
Norwegian Rescue set
Set de secours norvégien
210x100 mm / 8.2x3.9"







158780401
Ford F150 All Blacks



158880401
Ford Mustang GT All Blacks



158980401
Team Van All Blacks



639980401
All Blacks Set



159080401
St John Ambulance



159180402
New Zealand Fire Truck



159880403
New Zealand Police Car



182080403
New Zealand Emergency Set
210x75x110 mm / 8.3x3.0x4.3"
1:87



164780402
Life Flight Westpac Rescue Helicopter
1:87



185080402
Life Flight Westpac Rescue Helicopter and Ambulance Set
1:87
250x75x61 mm / 9.8x3.0x2.4"



210880404
St John Ambulance
1:50
175x87x59 mm/6.9x3.4x2.3"



*Bei Interesse wenden Sie sich bitte an unseren Importeur im jeweiligen Land · If you are interested, please contact our importer in the respective country · Si vous êtes intéressé, s'il vous plaît contacter notre importateur dans le pays respectif



080672801
Police Van



080872801
Command Car



182472801
Police Set

210x100 mm / 8.2x3.9"



104972801
Police Motorbike



103672801
Fire Engine



181872801

Fire Brigade Set

210x100 mm / 8.2x3.9"



140272802
Patrol Car



101472801
Firefighter Car



INTERNATIONAL



POLAND*

SIKUIINTERNATIONAL

siku

080606001
Police Van



080806001
Command Car



080906001
Ambulance



108306001
Emergency Service



104906001
Police Motorbike



103606001
Fire Engine



141006000
Patrol Car



181806000
Fire Brigade Set
208x96 mm/8.2x3.8"



181906001
Emergency Set
208x96 mm/8.2x3.8"



182506000
Ambulance Set
208x96 mm/8.2x3.8"



*Bei Interesse wenden Sie sich bitte an unseren Importeur im jeweiligen Land · If you are interested, please contact our importer in the respective country · Si vous êtes intéressé, s'il vous plaît contacter notre importateur dans le pays respectif



230606101
hasiči Mercedes AMG G65
1:50
155x75x65 mm / 6.9x3.4x2.3"



4 006874 823062





230806101
policie Mercedes AMG G65
1:50
155x75x65 mm / 6.9x3.4x2.3"



4 006874 823086





234506101
ambulance Mercedes AMG G65
1:50
155x75x65 mm / 6.9x3.4x2.3"



4 006874 823451





234806102
policie BMW i8 LCI
1:50
155x75x65 mm / 6.1x3.0x2.6"



4 006874 823482





080606100
policie van



4 006874 208087



080806101
hasiči dodávka



4 006874 4918080



080906101
ambulance dodávka



4 006874 492097



104906100
policie motorka



4 006874 493496



103606101
velké hasičské auto



4 006874 4910366



108306101
ambulance pohotovost



4 006874 493830



161506102
tramvaj



4 006874 616152





161706101
autobus v českých barvách



4 006874 4916177

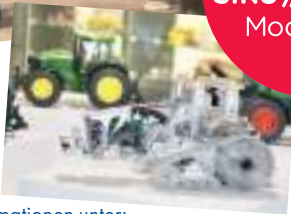

INTERNATIONAL



Weitere Informationen unter:
Further information:
Pour de plus amples informations :

www.modellwelt-luedenscheid.de
Facebook.com/siku.wiking.modellwelt

Erleben sie siku hautnah in unserer Modellwelt.

Lüdenscheid im Sauerland ist eine Reise wert. In unserer SIKU//WIKING Modellwelt erleben Sie über 3.500 Ausstellungsstücke aus über 100 Jahren Unternehmensgeschichte. Von den Anfängen bis hin zu den neuesten Entwicklungen. Entdecken und erleben Sie unsere fantastische Modellwelt, ob in Eigenregie, in Verbindung mit einer Führung oder als Event, Turnier oder als Geburtstagsfeier. Ob Groß oder Klein: Wir freuen uns auf Sie.

Experience siku up close at our Model World.

Come visit us and experience from up close our SIKU//WIKING Model World in Lüdenscheid, Germany. At our SIKU//WIKING Model World, you can admire 3,500 exhibits from over 100 years of our company's history. These range from the very first toys we produced, all the way through to our latest developments. Discover and explore our fantastic Model World – independently or as part of a guided tour. The SIKU//WIKING Model World is also the perfect venue for events such as birthday parties and excursions with your company or club. Visitors of all ages are always welcome here.

Découvrez siku au plus près en visitant notre musée SIKU//WIKING Modellwelt.

Rends-nous visite et découvre siku au plus près dans notre musée „Modellwelt“ de Lüdenscheid dédié aux marques SIKU //WIKING. Dans notre musée de SIKU//WIKING, tu découvriras plus de 3 500 modèles d'exposition créés au cours des plus de 100 ans d'existence de notre entreprise. De nos tous débuts à nos toutes dernières créations. Découvre et expérimente notre fantastique musée "Modellwelt" de manière autonome ou dans le cadre d'une visite guidée. Le musée "Modellwelt" de SIKU//WIKING constitue également un endroit idéal pour accueillir des célébrations d'anniversaire et des sorties d'entreprises ou d'associations. Petits ou grands : nous serons enchantés de votre visite.

KATALOGE | CATALOGUES BÜCHER | BOOKS | LIVRES



709800000
bambino LÜK-Set
Meine siku Fahrzeuge
- Logisches Denken



Im Set enthalten sind:
- bambinoLÜK-Kontrollgerät
- Übungsheft „Meine siku Fahrzeuge - Logisches Denken“
- siku Feuerwehr Unimog



929600000
Das siku Buch



Auflage: 1. Auflage 2023
Verlag: Delius Klasing
Ausstattung: Gebunden
ISBN: 978-3-667-12659-7
Seiten: 224
Format: 23.0 x 23.0 cm
Fotos und Abbildungen: 250

Édition : 1ère édition 2023
Éditeur : Delius Klasing
Édition : Relié
ISBN : 978-3-667-12659-7
pages : 224
Format : 23.0 x 23.0 cm
Photos et illustrations : 250

Edition: 1st edition 2023
Publisher: Delius Klasing
Features: Hardback
ISBN: 978-3-667-12659-7
Pages: 224
Format: 23.0 x 23.0 cm
Photos and illustrations: 250

900100000
siku-Händler-
Katalog 2024
siku trade catalogue 2024
Catalogue siku 2024



900200000
siku-Verbraucher-
Katalog 2024
siku consumer catalogue 2024
Catalogue consommateur siku 2024



Beide Kataloge sind auch als Blätterkataloge auf der Homepage zu finden.

Both catalogues are also available on the homepage as flip catalogues.

Les deux catalogues sont disponibles sous forme de catalogues à feuilletter sur le site.

NATIONAL

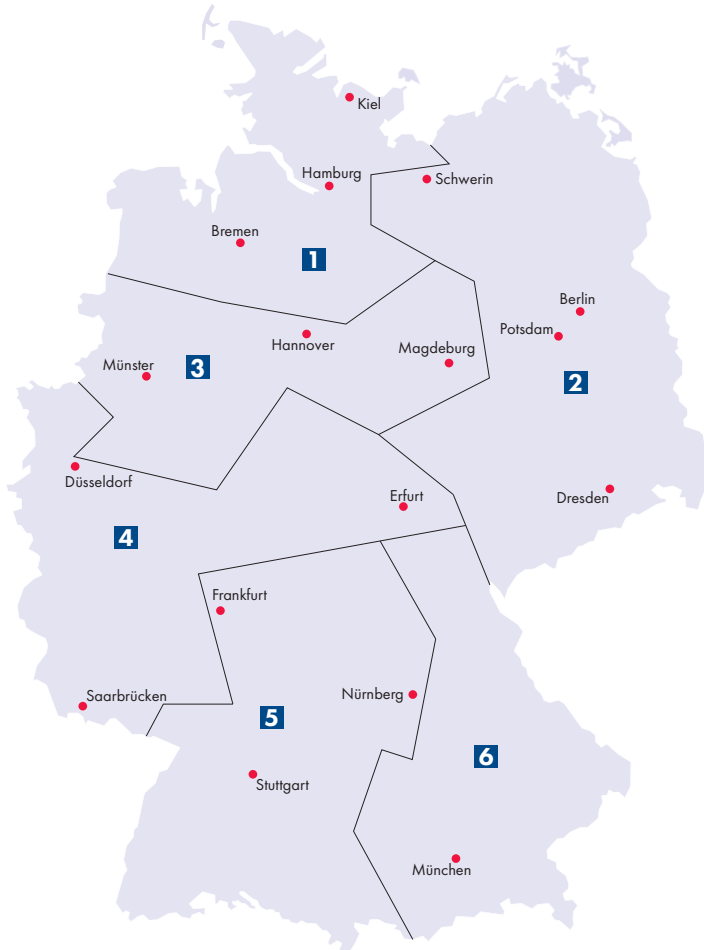

INTERNATIONAL

(S) Eigene Niederlassung • Subsidiary • Filiale

Deutschland / Germany (S)

Sieper GmbH
Schlittenbacher Str. 60
58511 Lüdenscheid
Postfach 25 69
58475 Lüdenscheid
Tel. +49 2351 876 0
Fax +49 2351 876 422
info@siku.de
www.siku.de

Österreich / Austria (S)

Wolfgang Strauß
Leitersdorf 34
8504 Preding
Tel. +43 664 187 47 17
Fax +43 3185 2022889
wolfgang.strauss@siku.de

Österreich / Austria (R)

CK-Toys
Handelsagentur
Christian Kaiblinger
Steinerstraße 27 b
5071 Wals
Tel. +43 664 835 06 30
office@ck-toys.at

Frankreich / France (S)

Sieper France SARL
153 boulevard Haussmann
75008 Paris
Tel. +33 1 30 68 08 36
accueil@siku.fr
www.siku.de

Asien / Asia Pacific (S)

Tim Toys Limited
Unit 1024, 10/F Star House
3 Salisbury Road, Tsim Sha Tsui
Kowloon, Hong Kong
Tel. +852 2661 12 77
Fax +852 2661 11 77
enquiry@timtoy.com



Alle Niederlassungen finden Sie auch unter www.siku.de

Find all subsidiaries also under www.siku.de

Trouvez toutes les filiales aussi sur www.siku.de

(I) Importeure siku • Importers siku • Importateurs siku

(R) Vertretungen • Representatives • Représentants

Australien / Australia (I)

Modern Brands Ptd Ltd.
Level 1, 122-126 Old Pittwater Road
Brookvale, NSW 2100
Tel. +61 1800 675772
Fax +61 1800 649982
sales@modernbrands.com.au
www.modernbrands.com.au

Estland / Estonia (I)

Letland / Latvia (I)
Litauen / Lithuania (I)
Kirkland OÜ
Kadaka Tee 54/2, 12915 Tallinn
Tel. +372 653 2038
Fax +372 653 2598
kirkland@kirkland.ee
www.kirkland.ee

Belgien / Belgium

► Frankreich/France

Finnland/Finland

► Dänemark / Denmark

China (I)

Kidsland Trading Company (Beijing) Ltd.
9F, ONE INDIGO,
20 Jiuxianqiao Road,
Chaoyang District, Beijing 100016
Tel. +86 10 6448 2105
Fax +86 10 8458 5977
postmaster@kidslandchina.com
www.kidslandchina.com

Griechenland / Greece (I)

Gialamas D. & Co
Industrial Area of Sindos
P.C. 57 022 Thessaloniki
Tel. +30 2310 784851 2
Fax +30 2310 784853
info@gialamas.gr
www.gialamas.gr

Dänemark / Denmark

Maki A/S
Nydamsvej 21
8362 Høring
Tel. +45 44476603
sales@maki.dk
www.maki.dk

Den für Ihren Bereich zuständigen Vertreter finden Sie auch unter:
www.siku-haendlerportal.de

Sieper GmbH
Schlittenbacher Str. 60
58511 Lüdenscheid, Germany
Postfach 25 69
58475 Lüdenscheid, Germany
Tel. +49 2351 876-0
Fax +49 2351 876-422
info@siku.de
www.siku.de

1 Mathias Esselbach
Paul-Schröder Str. 22
24229 Dänischenhagen
Tel. (04349) 2281175
Fax (04349) 2281176
mathias.esselbach@siku.de

3 Martin Hensmann
Mühlendamm 21b
59387 Ascheberg-Davensberg
Mobil:0151 270108 81
martin.hensmann@siku.de

5 Timo Becker
Friedrichstraße 47
72800 Eningen u.A.
Tel. (07121) 880350
Fax (07121) 880262
timo.becker@siku.de

2 René Greiner
Ottostraße 6
16562 Hohen Neuendorf
Mobil:0151 542 814 92
Fax (03303) 54186 15
rene.greiner@siku.de

4 Tobias Stein
Gartenstr. 9a
53773 Hennef
Mobil:0175 20 90 176
Fax (02242) 8745957
tobias.stein@siku.de

6 Werner Wittmeir
Pfarrer-Haas-Str. 3
86568 Hollenbach
Tel. (08257) 997422
Fax (08257) 8359
werner.wittmeir@siku.de

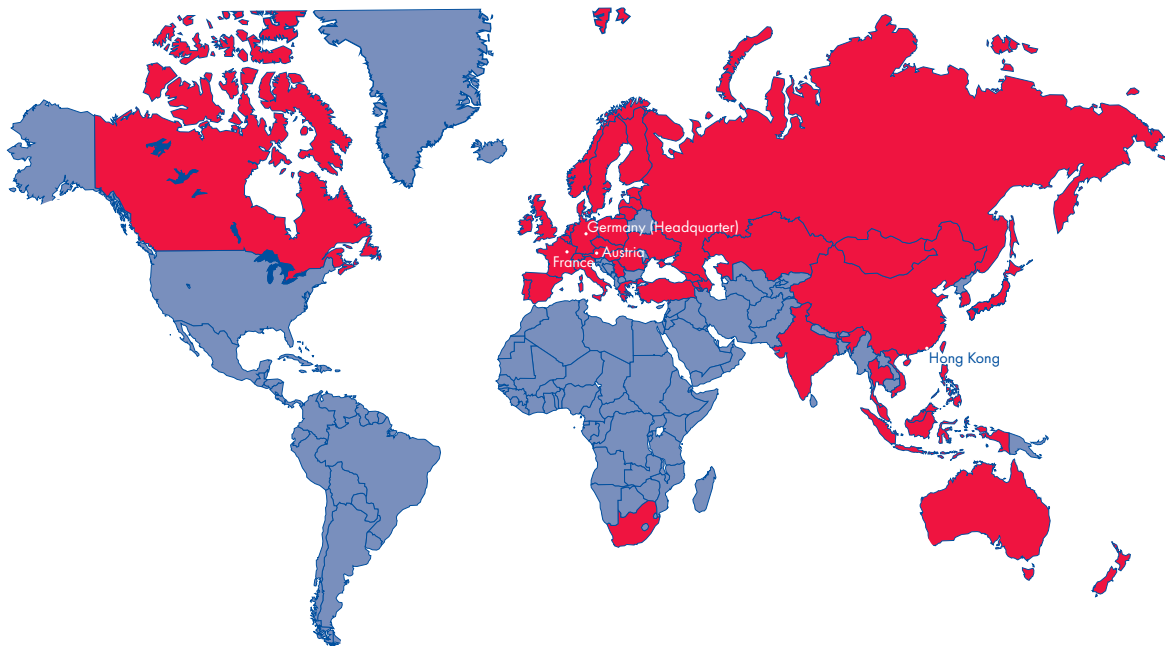

Großbritannien / Great Britain (I)

Alpha Toys Ltd.
Trinity Court
Church Street
Rickmansworth
Hertfordshire
WD3 1RT
Tel. +35367 63800
info@alpha-toys.co.uk
www.alpha-toys.co.uk
Contact: Banaghan & Co. Ltd. (Ireland)

Hong Kong (I)

Wise Kids Development Limited
Suite 4703 Central Plaza
18 Harbour Road, Wanchai
Tel. +852 2827 0882
Fax +852 2827 7733
cservice@wisekidstoys.com
www.wisekidstoys.com

Kuen Kee Trading Co. Ltd.
9/F Edwick Industrial Centre
4-30 Lei Muk Road
Kwai Chung, N.T.
Tel. +852 2780 2206
Fax +852 2385 2592
kkctoys@netnavigator.com

Indien / India (I)

Funskool India Ltd.
Tarapore Towers, VI Floor,
826, Anna Salai
Chennai – 600 002
Tel. +91 44 3026 26 26
Fax +91 44 3026 26 27
www.funskool.com

Indonesien / Indonesia (I)

PT MAP AKTIF ADIPERKASA, TBK.
26th Floor, Sahid Sudirman Center
Jl. Jend. Sudirman Kav.86, Jakarta
10220 Indonesia
Tel. +62 21 574 5808
www.mapactive.id

Irland / Ireland (I)

Banaghan & Co. Ltd.
Steream Centre
Limerick Rd., Nenagh
Co. Tipperary
Tel. +35367 63800
info@banaghans.ie
www.banaghans.ie

Island/Iceland

► Schweden /Sweden

Italien / Italy (I)

FIGLI DI PIETRO RODESCHINI S.p.A.
Via Buonarroti 4,
24020 Gorle
Tel. +39 035 3266 11
Fax +39 035 3266 99
rodeschini@rodeschini.it
www.rodeschini.it

Regione: Alto Adige, Friuli Venezia Giulia, Umbria, Marche, Lazio, Abruzzo, Molise, Campania, Puglia, Basilicata, Calabria, Sicilia, Sardegna

H. Klammssteiner OHG-SNC
Altmannstr. 15
39100 Bozen - Bolzano
Tel. +39 0471 91 27 81
Fax +39 0471 91 51 68
info@hklammsteiner.com
www.klammssteiner.net

Japan (I)

Bornelund Inc
3F 1-3-12, Jingumae, Shibuya-ku
Tokyo, 150-0001
Tel. +81 3 5785 0860
Fax +81 3 5785 0861
info@bornelund.co.jp
www.bornelund.co.jp

Süd-Korea / South Korea (I)

Nabita World Co., Ltd.
5th Fl, 34, Yangcheon-ro,
Gangseo-gu, Seoul,
Republic of Korea (07602)
Tel. +82-31-996-8855
Fax +82-31-987-0522
info@nabita.com
www.nabita.com

Luxemburg / Luxembourg (I)

Domilux SARL
28, route de Capellen
8279 Holzem
Tel. +352 691 704 464
domilux@pt.lu

Malaysia (I)

GBS Marketing Sdn Bhd
No 7, Lorong Tandang B,
Seksyen 51, 46050
Petaling Jaya, Selangor
Malaysia
Tel. +60 377 857 762
Fax +60 377 731 070
inquiries@gbs.com.my

Mongolei / Mongolia (I)

BRICKLAND LLC, 8th floor,
Altai construction building, Chinggis
avenue,
1st khoroo, Sukhbaatar district,
Post Code: 14201
Ulaanbaatar, Mongolia
Tel. +976 7575 7435
info@brickhouse.mn
www.brickhouse.mn

Neuseeland / New Zealand (I)

Harvey Wholesale NZ Ltd
10A – 25 Airborne Rd
Rosedale 0632
Auckland
NEW ZEALAND
Tel. +64 9 415 4000
Fax +64 9 415 3377
Email: sales@harveywholesale.co.nz
www.harveywholesale.co.nz

Niederlande / Netherlands

Sieper GmbH
Schlittenbacher Str. 60
58511 Lüdenscheid
Tel. +49 2351 876 0
Fax +49 2351 876 422
nederland@siku.de
www.siku.nl

Norwegen/Norway

► Dänemark / Denmark

Polen / Poland (I)

Trefl S.A.
Ul. Kontenerowa 25
81-155 Gdynia
Tel. +48 58 666 71 00
Fax +48 58 666 71 07
trefl@trefl.com
www.trefl.com

Portugal (I)

Dreamtoys
Núcleo Empresarial Venda
do Pinheiro Norte
Rua B nº 25 e 26
2665-601 Venda do Pinheiro
Tel. +351 217 597 048
geral@dreamtoys.pt
www.dreamtoys.pt

Rumänien / Romania (I)

RT CENTER SRL
11A, Bobalna Str., 550155 Sibiu
Tel. +40 742 141 585
contact@rollytoys.ro
www.jucariipremium.ro

Russland / Russia (I)

Konik LTD
Skotoprogonnaya str, 29/1
109029, Moscow
Tel. +7(495)7390057
Fax +7(812)7406368
info@konik.ru
www.konik.ru

Serbien / Serbia (I)

Licence Only d.o.o.
Trscanska 21
11080 Zemun
Tel. +381 113 713 613
Fax +381 113 713 651
office@licenceonly.net
www.licenceonly.net

Schweden / Sweden (I)

Micki Leksaker AB
Industrivägen 7
35573 Gemla, Sverige
Tel. +46 470 704150
info@micki.se
www.micki.se

Schweiz / Switzerland (I)

Carlit + Ravensburger AG
Grundstr. 9
5436 Würenlos
Tel. +41 56 436 8484
carlit.service@ravensburger.com
www.ravensburger.ch

Singapur / Singapore (I)

Learning Toys Asia Trading
No 18 Tannery Lane
05-03 Lian Tong Building
Singapore 347780
Tel. +65 6841 8905
Fax +65 6841 2807
tonyruak@learningtoys2u.com

Spanien / Spain

► Portugal

Südafrika / South Africa (I)

Jeffrey Stein
Sales PTY LTD.
P.O. BOX 13862
Mowbray, 7705
Tel. +27 21 44 24940
Fax +27 21 44 84037
info@jeffreysteijn.co.za
www.jeffreysteijn.co.za

Taiwan (I)

L.E. International Corp.
5F No. 346 Sec. 6
Nan-Jing East Road
Taipei City 114
Tel. +886 02 2795 5120
Fax +886 27 720 2395
www.funbox.com.tw

Thailand (I)

Nichiworld Co. Ltd.
991/12-15 Floraville Complex
Pattanakarn 51 Rd.
Suanluang, BKK 10250
Tel. +66 2722 3200
Fax +66 2722 3230
marketing@nichiworld.com

Tschechische Republik / Czech Republic (I)

Olymptoy s.r.o.
Okružní 781
25081 Nehvizdy
Tel. +420 321 740 100
Fax +420 321 740 110
info@olympoy.cz
www.olympoy.cz

Ukraine (I)

LLC «Smarty Family»
Of. 308, 19 Bozhenko St.
Odessa, 65098
Tel. +38 093 9692980
office@redhead.ua
www.redhead.ua

Ungarn / Hungary (I)

REGIO KFT
Nándorfejérvári út 23-25
H 1119 Budapest
Tel. +36 1 206 0805
Fax +36 1 206 0807
www.regiojatek.hu

Vietnam (I)

Viet Tinh Anh Joint Stock Company
33-35 Street #D4, Him Lam New
Residential Area,
Tan Hung Ward, District 7
Ho Chi Minh City, Vietnam
Tel. +84 8 54 318 717
Fax +84 8 54 318 716
info@viettinhanh.com.vn
www.siku.vn



WIKING ist das Traditionsunternehmen für Modelle in unterschiedlichen Maßstäben. Besuchen Sie uns unter www.wiking.de und stöbern dort im Blätterkatalog.

WIKING is the traditional company for collectibles in different scales. Visit us at www.wiking.de and browse through the catalogue there.

WIKING est l'entreprise de tradition pour des objets de collection à différentes échelles. Visitez-nous sur www.wiking.de et découvrez le catalogue.



765000000 (grün, green, verde) / **765100000** (schwarz, black, noir)

MAN TGS 4x4 BL 2-Achs Zugmaschine „Ackerdiesel“
MAN TGS 4x4 BL 2-Axle Truck “MAN green”
MAN TGS 4x4 BL Tracteur de camion à 2-essieux
250x160x125 mm / 9.8x5.9x4.9"



765300000 (rot, red, rouge) / **765200000** (weiß, white, blanche)

MAN TGS 4x4 BL 2-Achs Zugmaschine „Ackerdiesel“
MAN TGS 4x4 BL 2-Axle Truck “MAN green”
MAN TGS 4x4 BL Tracteur de camion à 2-essieux
250x160x125 mm / 9.8x5.9x4.9"

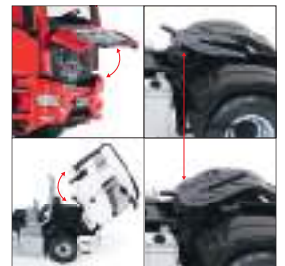

765400000 (schwarz, black, noir) / **765500000** (silber, silver, argent)

765600000 (grün, green, verde)
Kotte garant Tanksattelaufliieger TSA 30.000
Kotte garant tank semi-trailer TSA 30.000
Semi remorque citerne TSA 30.000
335x160x125 mm / 13x6.2x4.9"



765700000 (rot, red, rouge) / **765800000** (grau, grey, gris)

765900000 (schwarz, black, noir)
Krampe Rollbandwagen SB II 30/1070
Krampe Conveyor belt trailer SB II 30/1070
Remorques à tapis roulant SB II 30/1070
405x160x125 mm / 16x6.2x4.9"



Detaillierte Modelle für den Sammler ab 14 Jahren • Detailed Models for Collectors – 14 years and older • Modèles détaillés pour collectionneurs à partir de 14 ans.

782600000

Krampe Hakenlift THL 30 L mit Abrollcontainer Big Body 750
with roll-off container Big Body 750
avec conteneur à dérouler Big Body 750
320x130x125 mm / 12.5x5.1x4.9"



783400000

Claas Mährescher Commandor 116 CS mit Getreidevorsatz C660
Combine harvester with crop front C660
Moissonneuse-batteuse avec barre de coupe C660
370x160x260 mm / 14.5x6.3x10.2"



784000000

Liebherr Radlader L556
Four wheel loader L556
Chargeuse sur pneus L556
360x160x140 mm / 14.1x6.2x5.5"

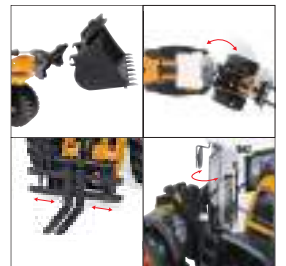

786800000 / 786900000

Fendt 728 Vario
230x160x125 mm / 9.1x6.2x4.9"
Fendt 724 Vario
mit Frontlader Cargo 6.100
with front loader
avec chargeur frontal
260x160x145 mm /
10.2x6.2x5.7"



787000000

John Deere 6R 250
230x160x125 mm / 9.1x6.2x4.9"



784800000
 JCB® Fastrac 8330
 250x160x125 mm / 9.8x6.3x4.9"

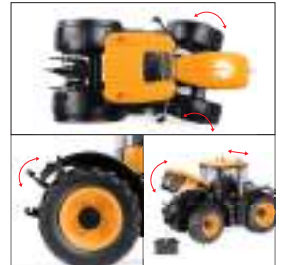

784900000
 John Deere® 9620RX
 300x160x125 mm / 11.8x6.3x4.9"

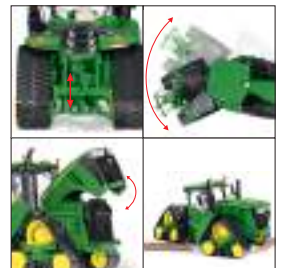

785000000
 Manitou Teleskoplader MLT 635
 Telescopic loader
 Chargeur télescopique
 230x160x125 mm / 9.1x6.2x4.9"

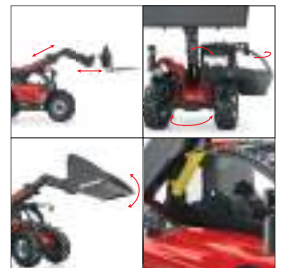

785200000
 IHC 1455 XL
 230x160x125 mm / 9.1x6.2x4.9"

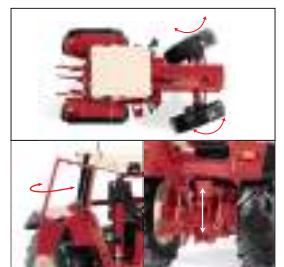

785300000
 Claas Xerion 4500
 290x160x160 mm / 11.4x6.2x6.2"



Detaillierte Modelle für den Sammler ab 14 Jahren. • Detailed Models for Collectors – 14 years and older • Modèles détaillés pour collectionneurs à partir de 14 ans.

785400000

Tandem-Halbrundmulde
Typ: Halfpipe HP 20
Benne demi-tube HP 20
250x120x115mm / 9.8x4.7x4.5"



785700000

Claas Trion 720 Montana mit Convio 1080 und Transportwagen
Claas Trion 720 Montana with Convio 1080 and trolley
Claas Trion 720 Montana Moissonneuse-batteuse avec barre de coupe Convio 1080 et chariot de transport
420x295x200mm / 16.5x11.6x7.8"



786300000

Claas Axion 950 Update
250x160x125mm / 9.8x6.3x4.9"



786400000

Fendt 1050 Vario
250x160x125mm / 9.8x6.3x4.9"



786600000 (weiß, white, blanche) / **786700000** (schwarz, black, noir)

Zweiachs-Dreiseitenkipper HKD 302
2 axle three-way tipper
Tri-benne à 2 essieux
280x160x125mm / 11x6.3x4.5"



Art-Nr.	Seite/Page	Art-Nr.	Seite/Page	Art-Nr.	Seite/Page	Art-Nr.	Seite/Page	Art-Nr.	Seite/Page	Art-Nr.	Seite/Page	Art-Nr.	Seite/Page
080100001	18	150700000	23	175000003	55	246500001	78	611300008	31	France		Hungary	
080200001	18	150900000	23	178900000	34	246600001	78	611600005	31	080600101	85	080606400	92
080400005	18	152000000	23	179000000	34	246700001	78	630400001	29	101400101	84	101406400	92
080500005	18	152100000	23	179100000	34	246800000	78	631200001	31	103600102	85	103606400	92
080700002	18	152300000	23	179300000	58	252600000	46	631400000	31	145000101	85	104906400	92
081100005	18	152400000	23	179400000	72	252700001	46	632300000	31	152500100	84	140206401	92
081300004	18	152500000	23	179600000	34	253900001	46	632400002	31	161700103	85		
081700002	18	152600000	23	179800000	35	254200003	47	632500001	29	163600103	84	Sverige	
082800006	18	152700002	23	179900000	72	254300003	47	632600001	31	164600103	85	138803000	92
084700001	18	152900001	23	180500001	72	254400007	47	632800001	29	179100101	85	138903001	92
085600001	18	153000000	23	180600002	34	256500001	47	632900001	30	181800100	84	145003001	92
085700003	18	153100000	23	180700001	35	271500001	48	633000001	30	181900100	85		
086600013	18	153300000	23	182600002	72	271700000	48	633100000	30	373400102	85	New Zealand	
086700009	18	153400001	23	182700002	72	287300001	78	633200000	30	373800101	85	158780401	93
087500008	18	153500001	23	183700001	72	287500002	78	633500000	30			158880401	93
089400000	18	153600002	23	184100003	35	288700002	66, 78	633600000	30	Österreich		158980401	93
089500000	18	153700001	23	184300002	73	289100001	79	650300000	16	080503802	86	159080401	93
100700013	19	153800001	24	184400001	73	289200001	79	650400000	16	146003800	86	159180402	93
101100002	19	153900000	24	184700003	35	289800000	79	650500000	16	253903802	86	159880403	93
101300003	19	154000000	24	184800001	73	293800003	48	650600000	17	271203804	86	164780402	93
101500004	19	154100000	24	184900001	35	294000003	48	650700000	17			182080403	93
102100005	19	154200001	24	185600001	73	304900001	79	650900000	17	Nederland		185080402	93
103000000	19	154300000	24	185800002	73	305900006	79	671300000	66	080500302	86	210880404	93
103400004	19	154400000	24	185900002	36	306100000	79	671400000	63	080600300	86	639980401	93
103700003	19	154500000	24	187400003	36	306700001	80	671500000	66	080800300	86		
105700001	19	154900000	24	187600002	73	306800001	79	671700000	62	101400300	86	South Korea	
106300000	19	156500000	24	187700002	36	309500001	83	673000000	62	103600300	86	080672801	94
106400000	19	156600000	24	188400002	36	327100001	80	673100000	62	145000301	86	080872801	94
107500004	19	156700000	24	188600005	36	327500002	80	673400000	62	181800300	86	101472801	94
107700001	19	156800000	24	189000003	36	328000001	80	673500000	64	181900300	86	103672801	94
107900001	19	156900000	24	189100003	37	328200001	80	673600000	64			104972801	94
108000001	19	157100000	24	189500003	37	328500001	80	673700000	62	Schweiz		140272802	94
108100000	19	157200000	24	189700003	37	328700001	81	673800000	64	037403903	87	181872801	94
108500006	19	157700000	24	189800002	37	329000000	81	673900000	64	182403906	87	182472801	94
109100000	19	157800000	24	192000002	38	329100000	81	674000002	63	2199703901	87		
109900000	19	157900000	24	192200001	38	329200000	81	674100000	63	2211503901	87	Poland	
110100000	20	158000001	24	192600000	38	329300000	82	674400000	62	2373803901	87	080606001	95
110300000	20	158100000	24	194100000	39	350600001	50	678000002	69			080806001	95
110400000	20	158200000	24	194400000	39	350700002	50	678100002	69	Great Britain		080906001	95
110500000	20	158300000	24	194500001	74	350900000	50	678200001	69	103606001	95	104906001	95
110600000	20	160500000	25	194700003	74	353000003	50	678600000	69	108306001	95		
110700000	20	160600000	25	194900002	74	353400002	50	678800000	65	141006000	95	145006001	88
129600000	20	161000003	25	195300003	74	353500005	50	678900000	65	163000701	88	163200701	88
129800000	20	161100002	25	195400003	74	353700003	51	679000000	65	163200701	88	163200701	88
130900003	20	161300002	25	197900002	75	353900003	51	679100000	66	164200701	88	164200701	88
131100001	20	161400001	25	198200002	75	354800001	51	679200000	67	164600701	88	164600701	88
131600002	20	161500010	25	198500002	75	355800002	52	679300000	68	226500001	89	226500001	89
131900003	20	161600002	25	198900001	76	355900000	52	679400000	66	226600704	89	226600704	89
132100002	21	161700006	25	199000000	75	356000000	52	679500000	67	226800001	89	226800001	89
132200003	21	162300003	25	199100004	76	356100001	52	679600000	68	227000701	89	227000701	89
132600004	21	162400005	26	199300004	76	356200001	52	679700000	68	245000701	89	245000701	89
134200010	21	162600003	26	199700002	39	356300000	52	679800000	68	246900701	89	246900701	89
135000003	21	162700009	26	199900002	76	365200001	82	688000004	70	325299900	89	325299900	89
135700003	21	162900004	26	200000001	76	365800001	83	688100004	70	366300701	89	366300701	89
136000010	21	163600005	26	206700000	77	366100000	83	688200004	70	383899901	89	383899901	89
138400001	21	164500003	26	206900000	77	366300002	82	701500000	83	621300707	88	621300707	88
138500000	21	164600003	26	211000002	40	373100002	53	709700000	7	621400702	88	621400702	88
139100001	21	164700005	26	211300000	41	373400004	53	709800000	97	628300002	88	628300002	88
139200000	21	165000002	26	211400001	41	373800000	53	900100000	97	628600002	88	628600002	88
139300000	21	165100004	26	211500001	41	392100001	53	900200000	97	629100701	88	629100701	88
139400000	21	165200001	26	211600001	41	406600001	82	929600000	97	860800001	89	860800001	89
139500000	21	165800007	26	211700000	41	411700000	53						
139600000	21	165900002	27	227000001	77	431100001	49	NEUHEITEN				WIKING	
139700000	21	166500001	27	230100000	42	481000001	49	107000011	10	Greece		765000000	100
139900000	21	166700005	27	230200000	42	487000001	83	129500000	10	080600900	90	765100000	100
140800001	22	166800001	27	230300001	43	491400005	49	150800003	10	080800900	90	765200000	100
141800002	22	167100006	27	230400000	43	540100001	55	153200000	12	080900900	90	765300000	100
144900001	22	167200004	27	230500001	43	540200001	56	154600000	12	103600900	90	765400000	100
145300002	22	167300001	27	230600002	43	550300000	57	155100000	10	103600900	90	765500000	100
145800000	22	167700001	27	230700001	43	550400000	57	155200000	10	104900900	90	765600000	100
146000007	22	167900000	27	230800002	43	550500004	57	155700000	12	108300900	90	765700000	100
146100003	22	168300000	27	230900003	43	550600000	57	155800000	12	141000902	90	765800000	100
146900005	22	168600001	28	234700000	44	550700001	58	158400000	10	141100901	90	765900000	100
147500001	22	168700000	28	234800001	44	550800001	59	158500000	10	143700901	90	782600000	101
147600001	22	168900000	28	234900001	44	551000000	59	168500002	10	145000901	90	783400000	101
147700000	22	169000001	28	235000002	44	551200000	55	170200000	12	146900900	90	784000000	101
147900000	22	169200002	28	235700000	45								





Sieper GmbH
Schlittenbacher Str. 60, 58511 Lüdenscheid, Germany
Postfach 25 69, 58475 Lüdenscheid, Germany
Telefon +49 (0) 2351 8 76-0
Fax +49 (0) 2351 8 76-422
info@siku.de

www.siku.de

